

## Новинки

*...новый выбор*

04-33



## Модерн

*...в духе современности*

34-51



## Классик

*...стиль и элегантность*

52-69



## Игрушки

*...многообразие красок*

70-73



## Керамика

*...в твоём стиле*

74-81



## Ретро

*...неизменное совершенство*

82-95



## Крючки

*...вызов повседневности*

96-99





# НОВИНКИ

04-33

Новинки - New

В данном разделе собраны ручки, отвечающие самым высоким требованиям и критериям современной моды. Мировые тенденции в области дизайна мебельной фурнитуры постоянно развиваются. Более широкие горизонты для полета творческой мысли открываются для дизайнеров. Форма ручек, замысловатые изгибы, камни в отделке, уникальный цвет - все это придаст вашей мебели более изысканный вид.

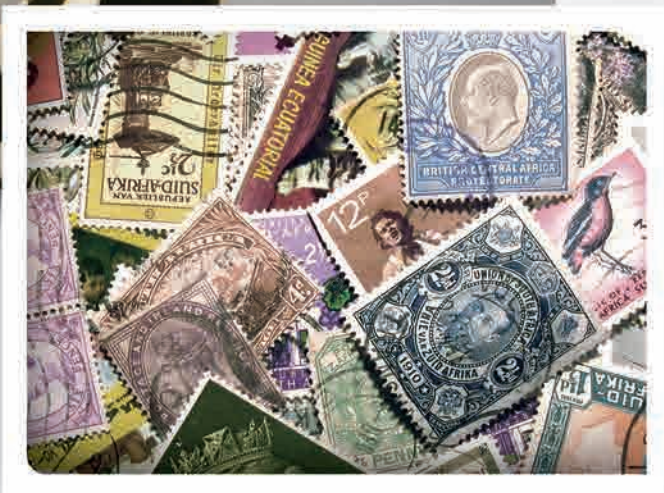



### KU 02

	↔	△	
KU 02	96	G2	L
KU 02	96	G2	R
KU 02	64	G2	L
KU 02	64	G2	R



KU 02 96/G2 R



KU 02 64/G2 L

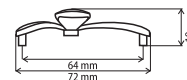
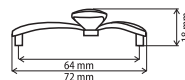
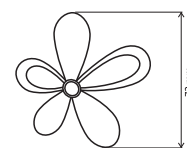
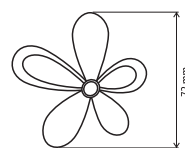
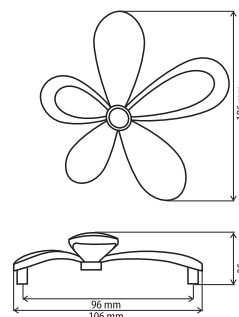
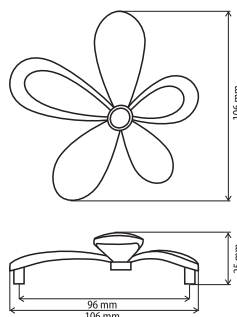



# KU 03

	↔	△	
KU 03	96	G2	L
KU 03	96	G2	R
KU 03	64	G2	L
KU 03	64	G2	R



KU 03 96/G2 L/R



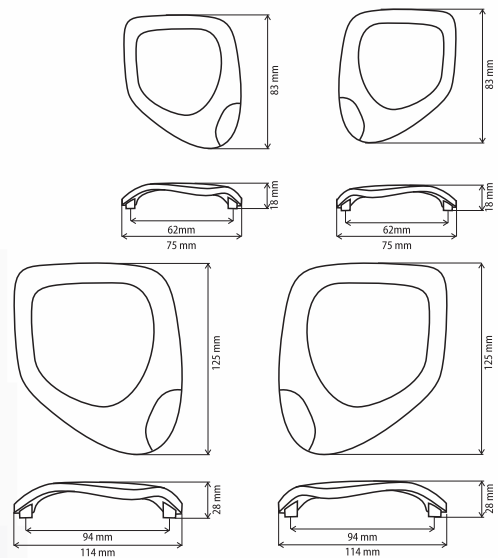

KU 03 64/G2 L





KU 01

		
KU 01	96	G2
KU 01	64	G2



KU 01 96/G2



KU 01 64/G2

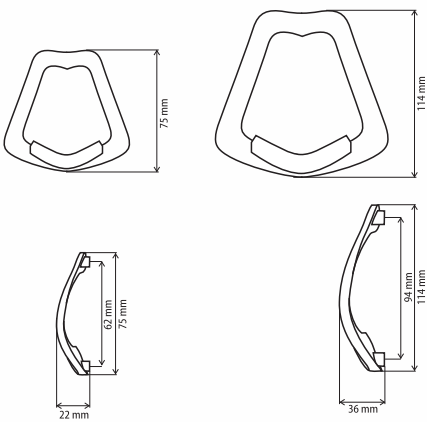

## DU 21

	↔	△
DU 21	96	G2 L
DU 21	96	G2 R
DU 21	96	G2 L
DU 21	96	G2 R

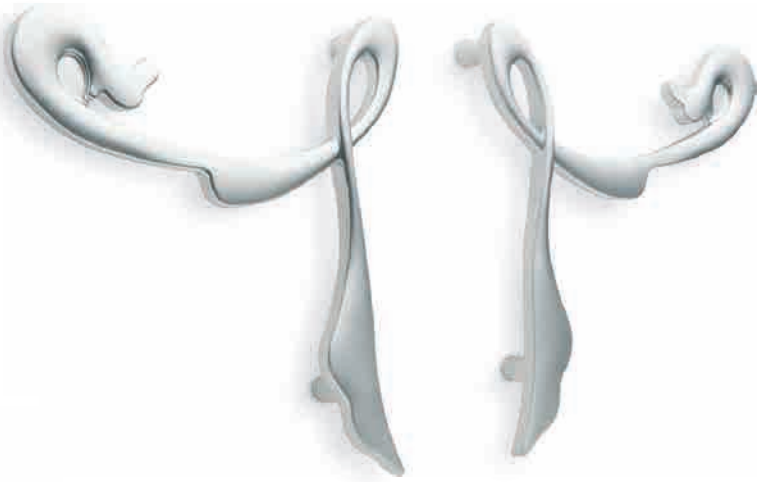

DU 21/96 G6 R/L NW



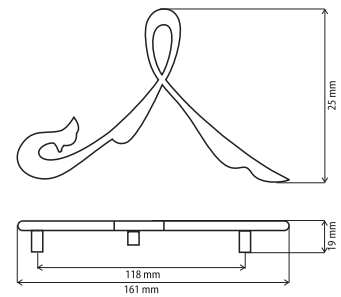

DU 21/96 G6 L NW





### DU 22

				
DU 22	96	AB		L
DU 22	96	AB		R
DU 22	96	G2		L
DU 22	96	G2		R
DU 22	96	G3		L
DU 22	96	G3		R
DU 22	96	G6		L
DU 22	96	G6		R



DU 22 96/G2 L



DU 22 96/G2 R

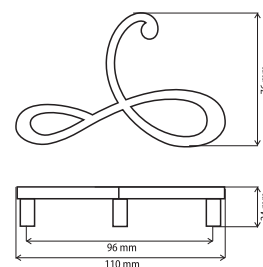



## DL 10A

DL 10A	↔	△	DL 10A	↔	△
DL 10A	320	G2	DL 10A	128	G6
DL 10A	320	G3	DL 10A	64	G2
DL 10A	320	G6	DL 10A	64	G3
DL 10A	160	G2	DL 10A	64	G6
DL 10A	160	G3	DL 10A	32	G2
DL 10A	160	G6	DL 10A	32	G3
DL 10A	128	G2	DL 10A	32	G6
DL 10A	128	G3			



DL 10A/320 G3



DL 10A/64 G3



DL 10A/128 G3



DL 10A/32 G3

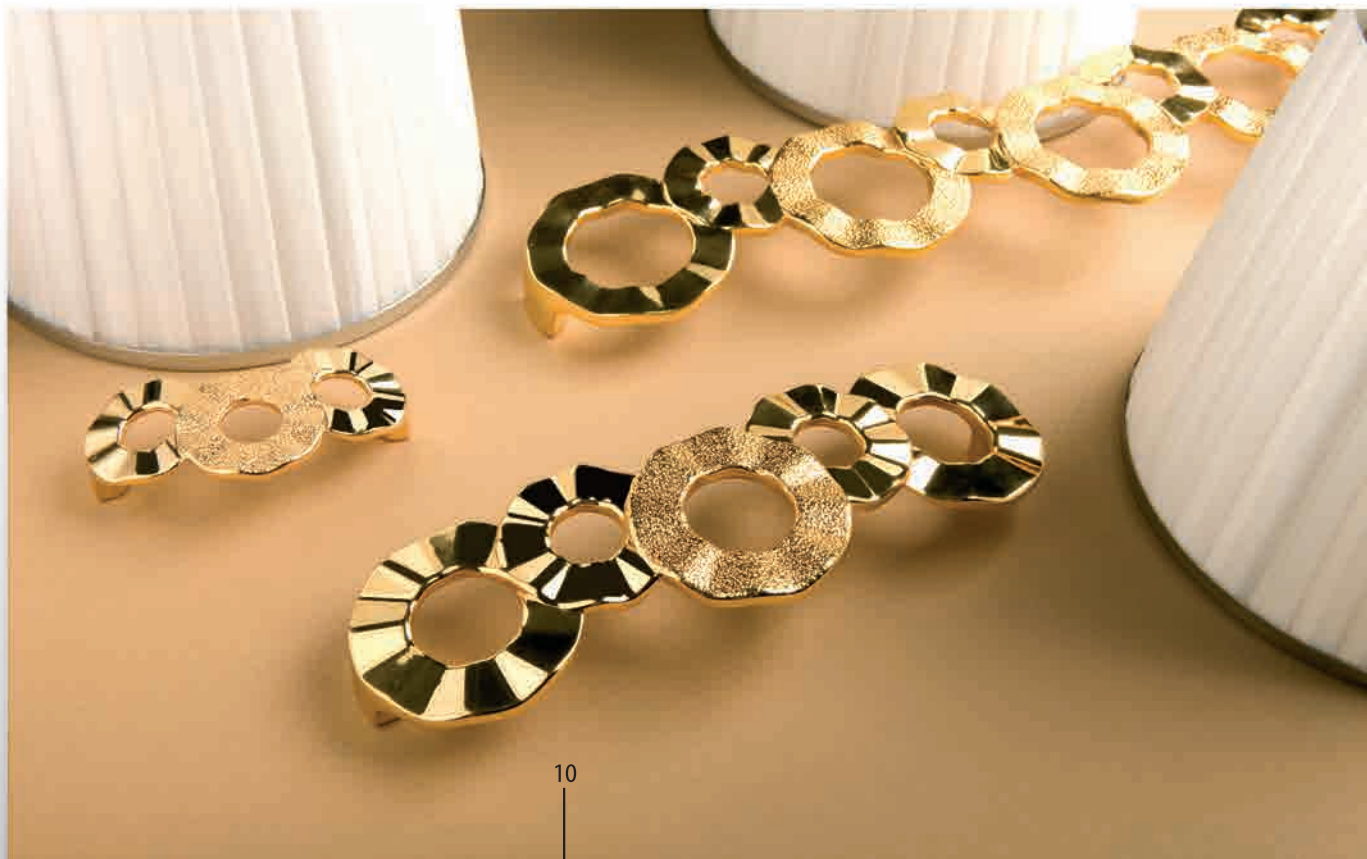
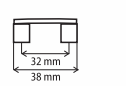
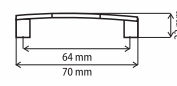
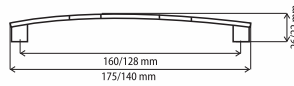
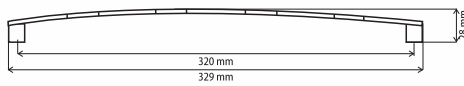



## DL 10

DL 10	↔	△
DL 10	320	G5
DL 10	160	G5
DL 10	128	G5
DL 10	64	G5
DL 10	32	G5



DL 10/320 G5



DL 10/160 G5



DL 10/128 G5



DL 10/64 G5



DL 10/32 G5

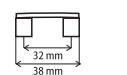
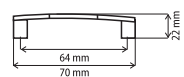
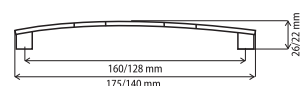
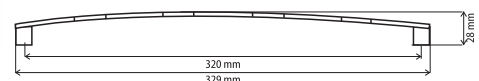



## DL 33

	↔	△
DL 33	256	G2
DL 33	256	G5
DL 33	256	G6
DL 33	192	G2
DL 33	192	G5
DL 33	192	G6
DL 33	160	G2
DL 33	160	G5
DL 33	160	G6

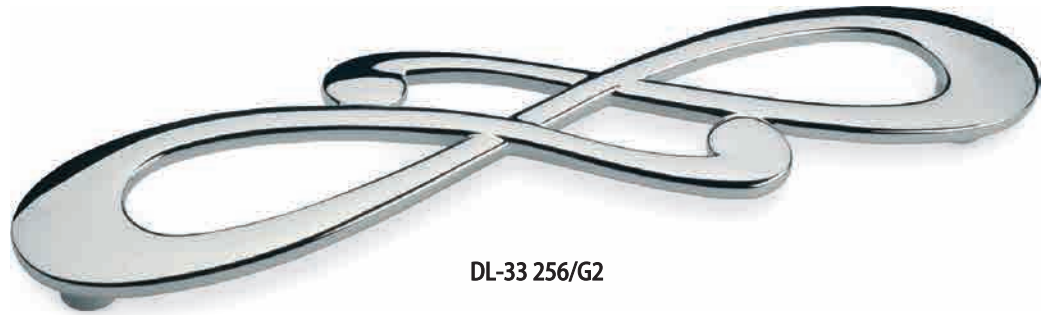

DL-33 256/G2



DL-33 160/G2

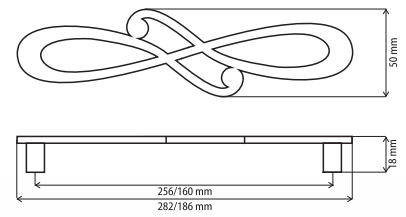



**DL 30**

DL 30	↔	△
DL 30	256	G2
DL 30	256	G6
DL 30	160	G2
DL 30	160	G6

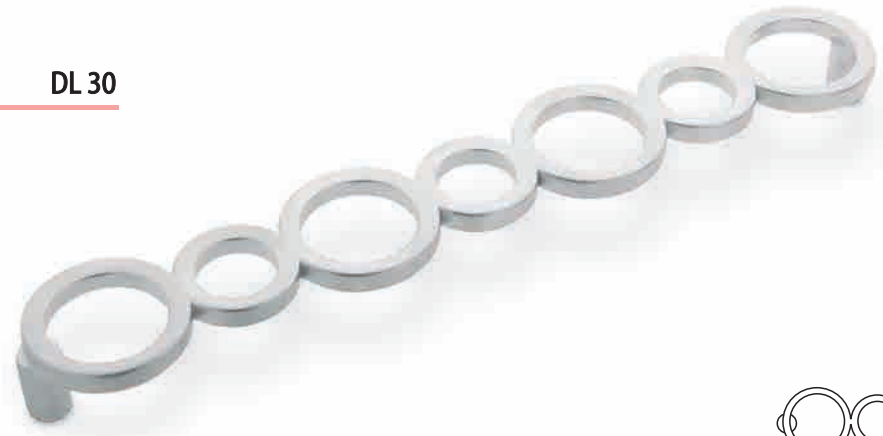

**DL-30/256 G6**

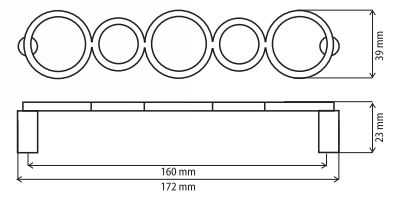

**DL-30 160/G2**

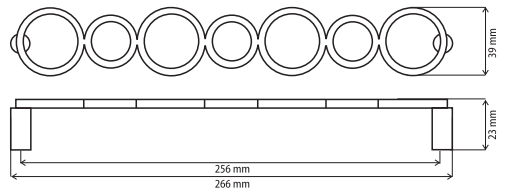

**DL 11**

DL 11	↔	△
DL 11	256	G2
DL 11	256	G3
DL 11	192	G2
DL 11	192	G3
DL 11	160	G2
DL 11	160	G3

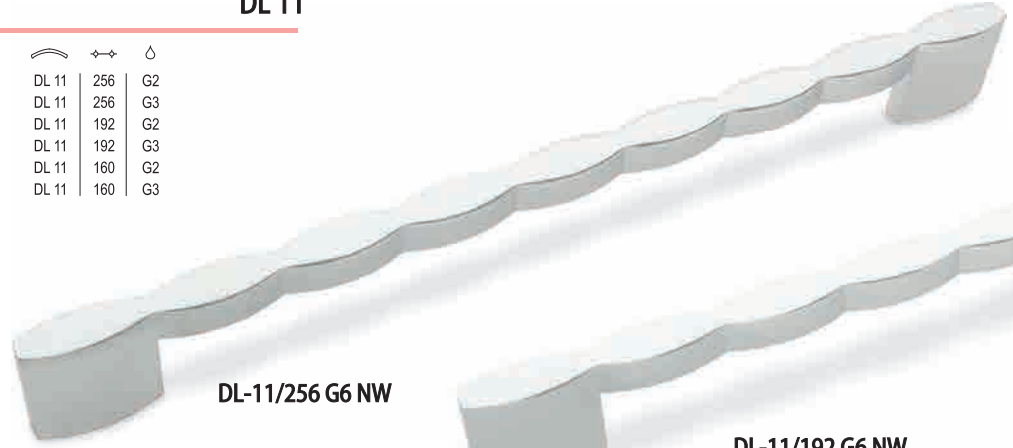

**DL-11/256 G6 NW**

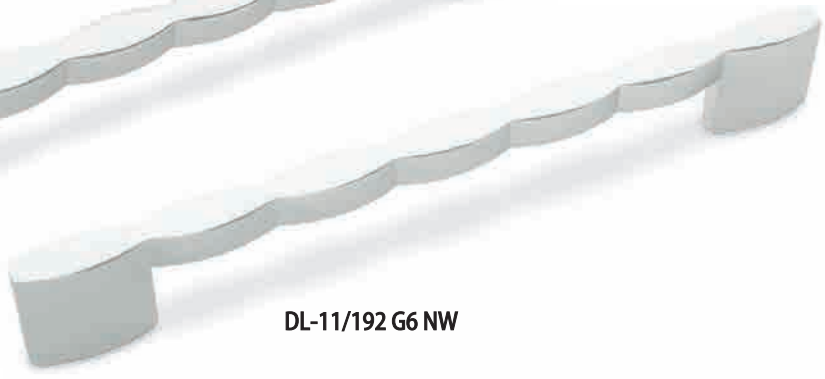

**DL-11/192 G6 NW**



**DL-11/160 G6 NW**

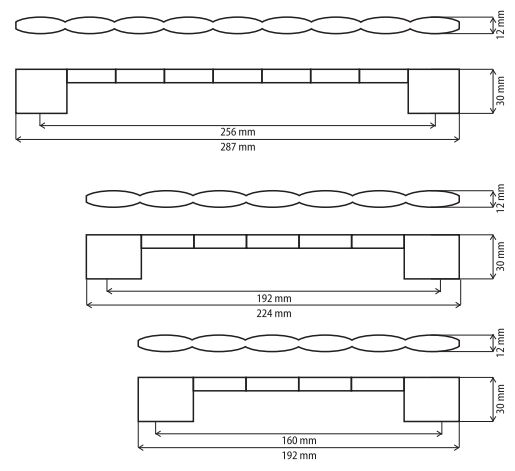



## DR 49

	↔	△
DR 49	160	AB
DR 49	160	G15
DR 49	160	G16
DR 49	128	AB
DR 49	128	G15
DR 49	128	G16
DR 49	96	AB
DR 49	96	G15
DR 49	96	G16



DR 49 96/G15

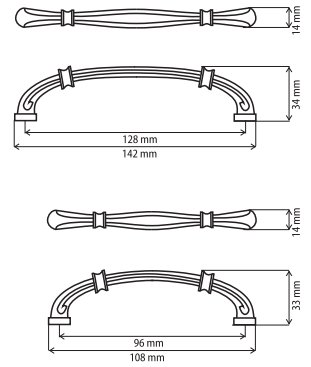

DR 49 128/AB



DR 49 128/G16



DS 07  
KL 07

Icon	Series	Length	Finish
⤿	DS 07	160	AB
↔	DS 07	160	G2
△	DS 07	160	G6
	DS 07	160	G15
	DS 07	160	G16
	DS 07	160	G17
	DS 07	128	AB
	DS 07	128	G2
	DS 07	128	G6
	DS 07	128	G15
	DS 07	128	G16
	DS 07	128	G17
	DS 07	96	AB
	DS 07	96	G2
	DS 07	96	G6
	DS 07	96	G15
	DS 07	96	G16
	DS 07	96	G17



DS 07 96/G17



DS 07 128/G17



KL 07/G17

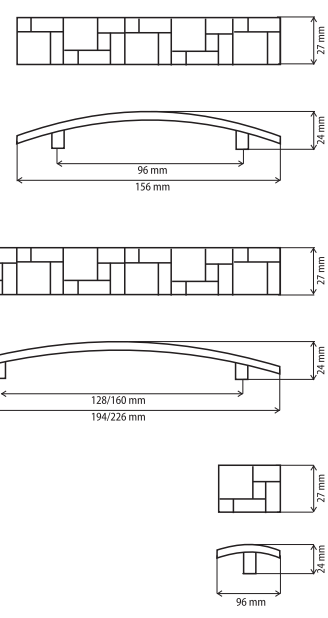





**DR 52**  
**KR 52**

	↔	△
DR 52	160	AB
DR 52	160	G15
DR 52	160	G16
DR 52	128	AB
DR 52	128	G15
DR 52	128	G16
DR 52	96	AB
DR 52	96	G15
DR 52	96	G16

⌋	△
KR 52	G15
KR 52	G16



**DR-52-96-AB**



**KR 52 G15**



**DR 52-128-G15**



**DR 52-96-G15**

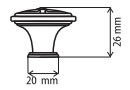
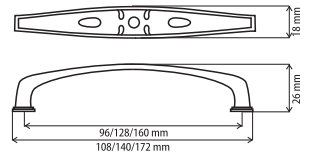

**DR 53**  
**KR 53**

DR 53	↔	△
DR 53	160	AB
DR 53	160	G15
DR 53	160	G16
DR 53	128	AB
DR 53	128	G15
DR 53	128	G16
DR 53	96	AB
DR 53	96	G15
DR 53	96	G16

KR 53	△
KR 53	AB
KR 53	G15
KR 53	G16



**DR 53 160/G16**



**DR 53 160/G15**



**DR 53 96/AB**

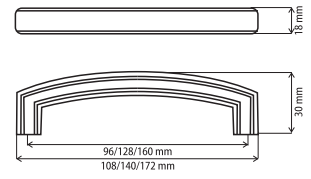

**KR 53 G16**

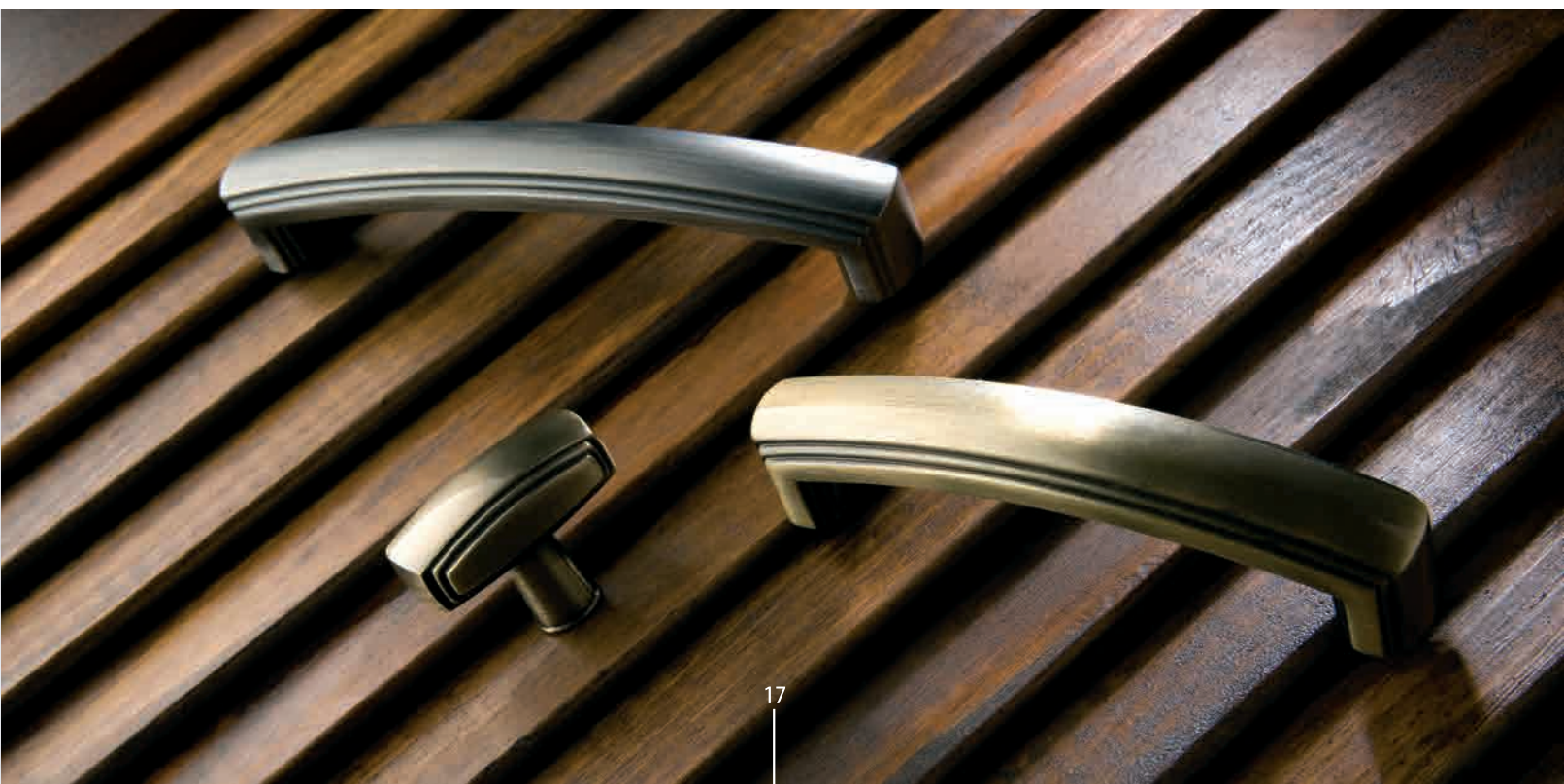



**DR 55**  
**KR 55**

DR 55	96	AB
DR 55	64	AB

KR 55	AB



**DR 55/64 AB**



**KR 55 AB**



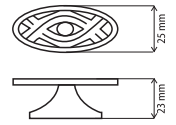
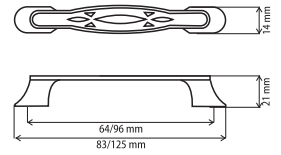

**DR 55/96 AB**





### KU 04

		
KU 04	96	G4
KU 04	64	G4
KU 04	32	G4



KU 04/96 G4

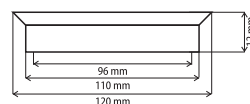

KU 04/32 G4



KU 04/64 G4

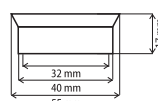
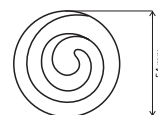
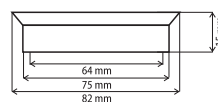

## DR 57





  
 DR 57 | 128 | AB  
 DR 57 | 96 | AB

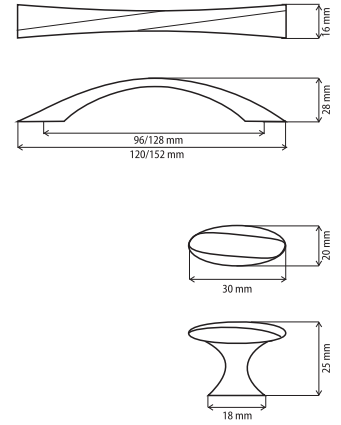

  
 KR 57 | AB



## DR 15 KR 15

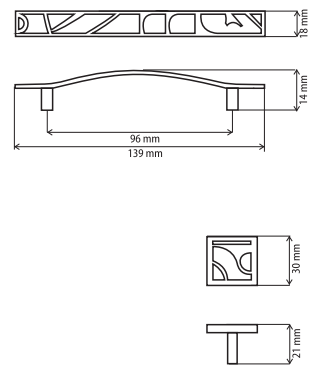

  
 DR 15 | 96 | AB

  
 KR 15 | G4



**DR 56  
KR 56**

DR 56 | 96 | AB

KR 56 | AB



**DR 56/69 AB**



**KR 56 AB**

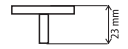
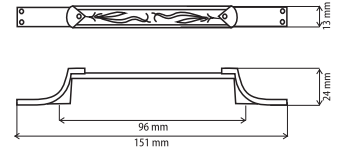

**DR 60  
KR 60**

DR 60 | 96 | G4

KR 60 | G4



**DR 60/96 G4**



**KR 60 G4**

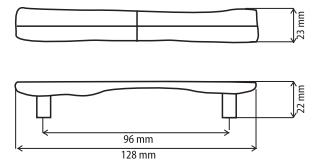



### DF 01

DF 01 | 76 | AB | 15



DF 01/76 AB

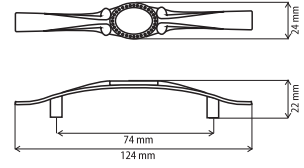

### DT 07

DT 07 | 76 | AB | 15



DT 07/76 AB/15

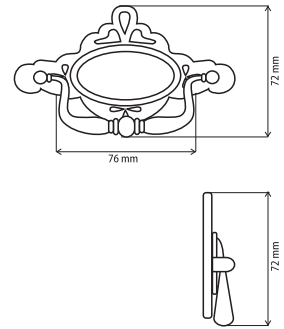

### KF 01

KF 01 | AB | 15



KF 01 AB

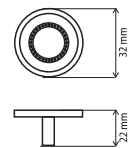

**DL 17  
KL 17**

		
DL 17	96	G2
DL 17	96	G5

	
KL 17	G2
KL 17	G5





**DL 17/96 G2**

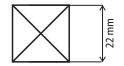
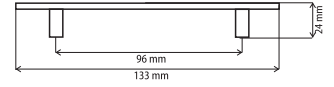
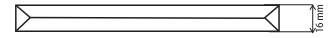

**KL 17 G2**



**DN 81**

		
DN 81	96	G2
DN 81	96	G3
DN 81	96	G5



**DN 81/96 G5**

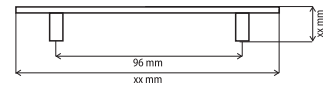



## DR 58

		
DR 58	128	AB
DR 58	96	AB

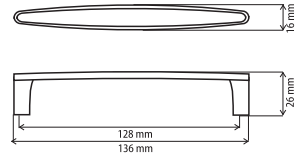

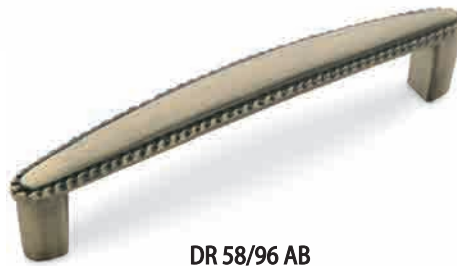

DR 58/128 AB



DR 58/96 AB

## DN 82

		
DN 82	128	AB
DN 82	128	G2
DN 82	128	G5
DN 82	96	AB
DN 82	96	G2
DN 82	96	G5





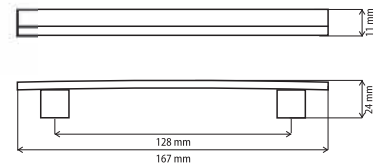

DN 82/128 AB





## DE 60

				
DE 60	224	G2	D12	
DE 60	224	G2	G5	
DE 60	192	G2	D12	
DE 60	192	G2	G5	
DE 60	160	G2	D12	
DE 60	160	G2	G5	
DE 60	128	G2	D12	
DE 60	128	G2	G5	

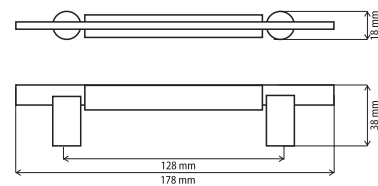

DE 60/224 G2/D12



DE 60/160 G2/D12



DE 60/160 G2/G5



DE 60/128 G2/G5



## DV 20

DV 20	224	AL	D12
DV 20	160	AL	D12
DV 20	128	AL	D12
DV 20	96	AL	D12

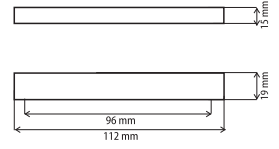

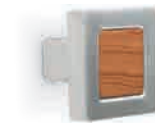
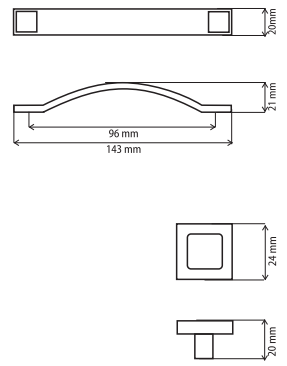

## DV 21 KV 21

DV 21	96	G6	D12
DV 21	96	G6	K4
KV 21	G6	D12	
KV 21	G6	K4	



**KV 21 G6/K4**

### KU 05

				
KU 05	L	G2	Glass	
KU 05	L	G6	Glass	
KU 05	S	G2	Glass	
KU 05	S	G6	Glass	

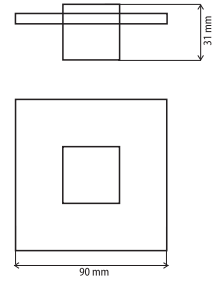

**KU 05/S G2/Glass**



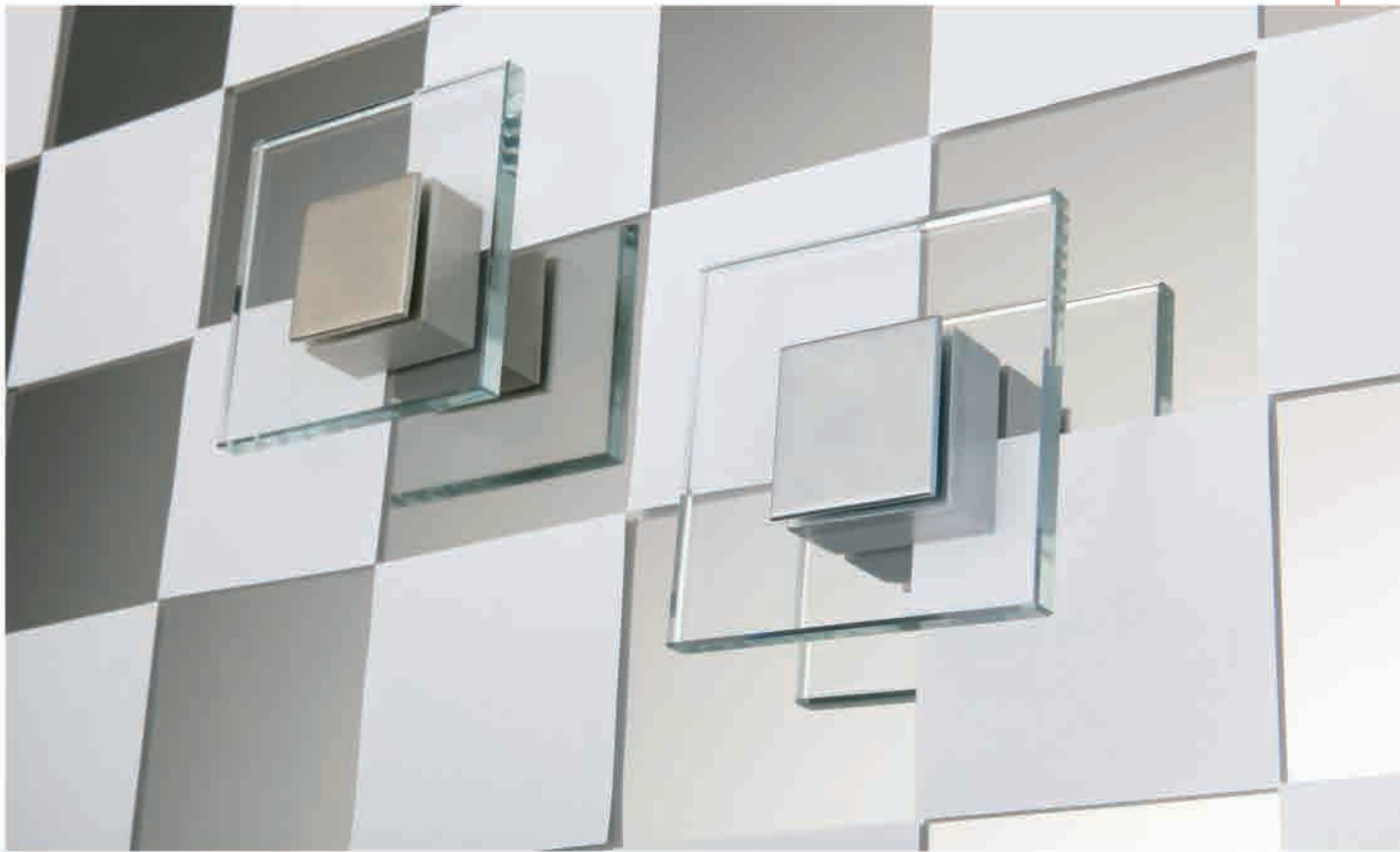

**KU 05/L G6/Glass**





## KU 06

			
KU 06	L	G2	Glass
KU 06	L	G5	Glass
KU 06	S	G2	Glass
KU 06	S	G5	Glass

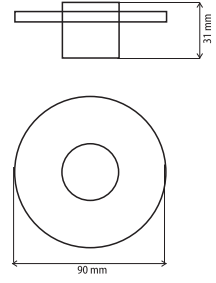

**KU 06/S G6/Glass**





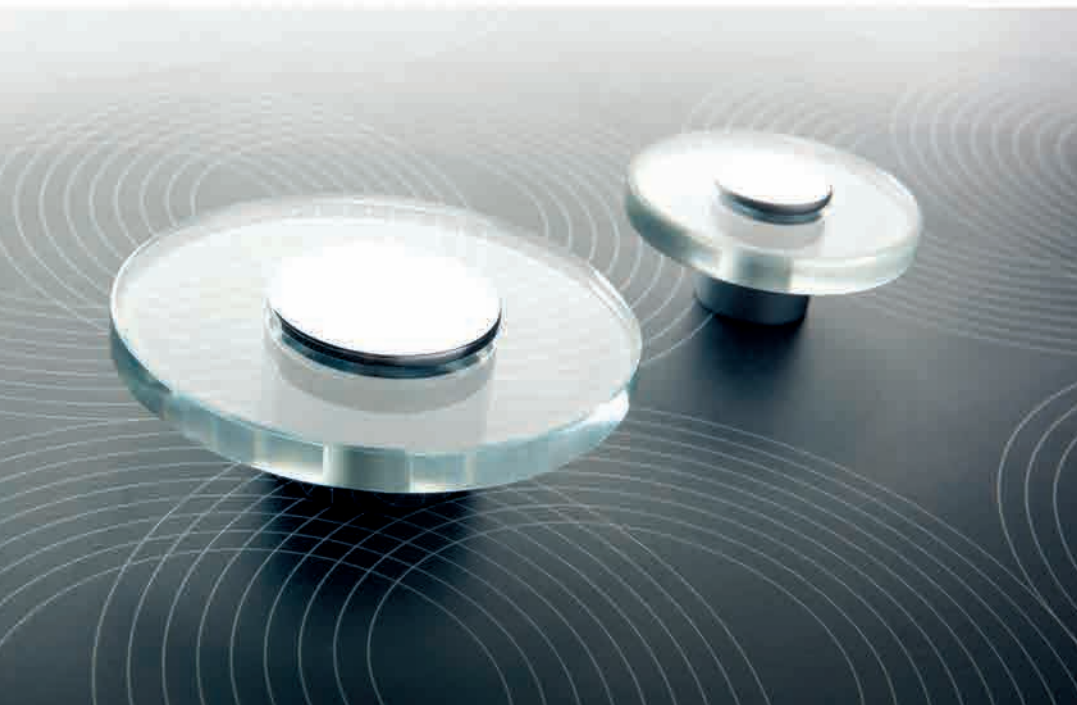

**KU 06/L G2/Glass**





## KU 31

					
KU 31	96	G2	BRN	Glass	
KU 31	32	G2	BRN	Glass	
KU 31	16	G2	BTN	Glass	

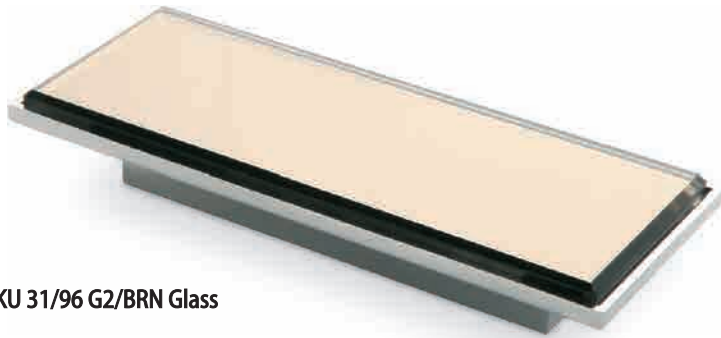

**KU 31/96 G2/BRN Glass**

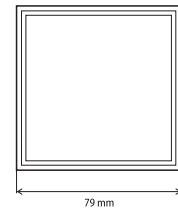
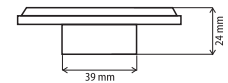
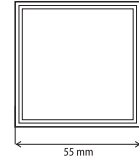
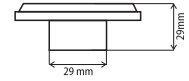

**KU 31/16 G2/BRN Glass**

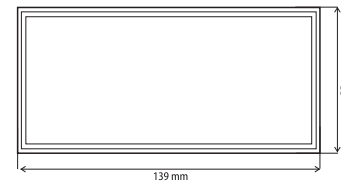
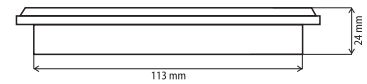

**KU 31/32 G2/BRN Glass**





**WN 01  
WN 02**

	△
WN 01	G2
WN 01	G5
WN 02	G2
WN 02	G5



**WN 02 G2**



**WN 01 G2**

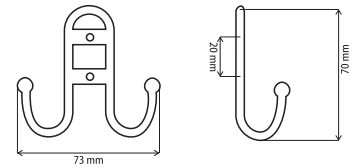
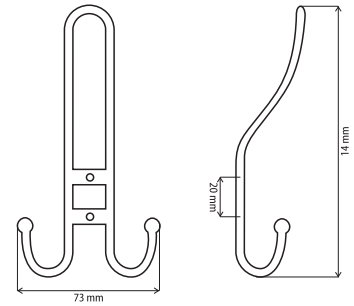

**M-005  
M-006**

	△
M-005	G2
M-005	G6
M-006	G2
M-006	G6



**M-006 G6 NW**



**M-005 G6 NW**

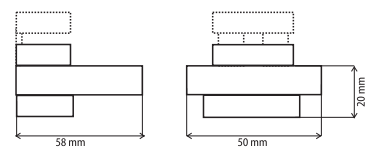
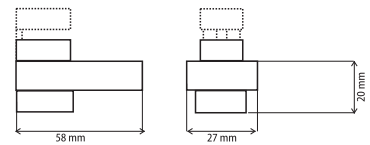

PL 11

PL 11 | AB  
PL 11 | G4

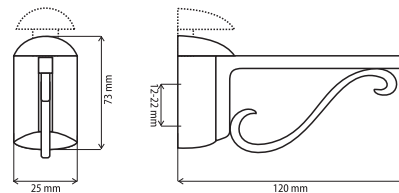

PL 11 AB NWL

WR 06  
WR 07

WR 06 | G4  
WR 07 | G4



WR 06 G4



WR 07 G4

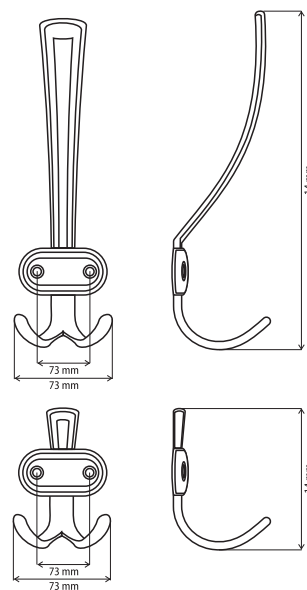

**WR 04**  
**WR 05**

   
 WR 04 | AB  
 WR 05 | AB



**WR 04 AB**



**WR 05 AB**

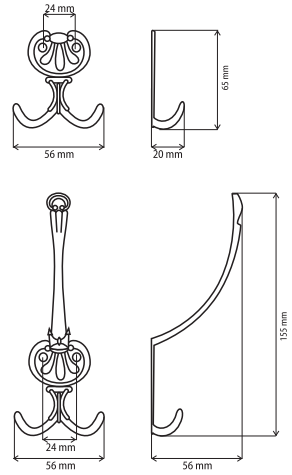







# Модерн

Модерн - Modern

Время модерна стремительным вихрем ворвалось в конце XIX века. Тогда на вершине требований человека к мебели оказались функциональность и комфорт. Фантазия художников и архитекторов перестала подчиняться стилистическим канонам прошлых эпох. Дизайн ручек модерна позволил воплотить идею сочетания металла, стекла, пластика, камня, а также гибких и прямых линий.





## D-753



  
 D-753 | 128 | G2



D-753/128 G2

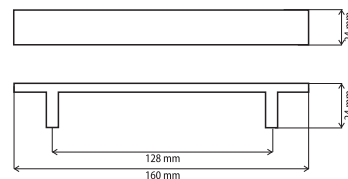

## K-749





  
 K-749 | G2

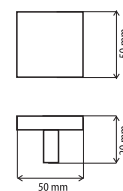

K-749/G2



## D-749





  
 D-749 | 96 | G2

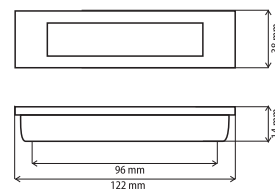

D-749/96 G2



## D-111



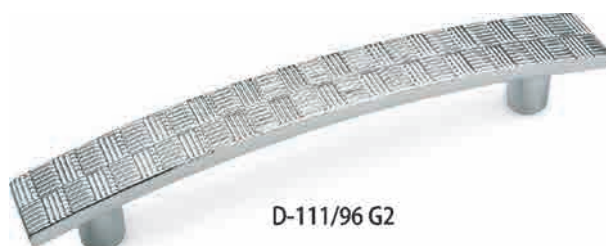

  
 D-111 | 96 | G2  
 D-111 | 96 | G3  
 D-111 | 96 | G6  
 D-111 | 96 | G30  
 D-111 | 64 | G2  
 D-111 | 64 | G3  
 D-111 | 64 | G6  
 D-111 | 64 | G30

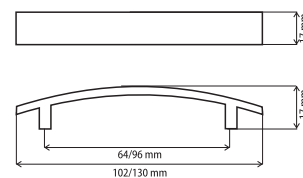

D-111/96 G2



## K-111

  
 K-111 | G2  
 K-111 | G3  
 K-111 | G6  
 K-111 | G30



K-111/G2

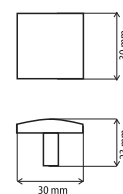



## D-726

	↔	△
D-726	160	G2
D-726	160	G3
D-726	160	G5
D-726	160	G6

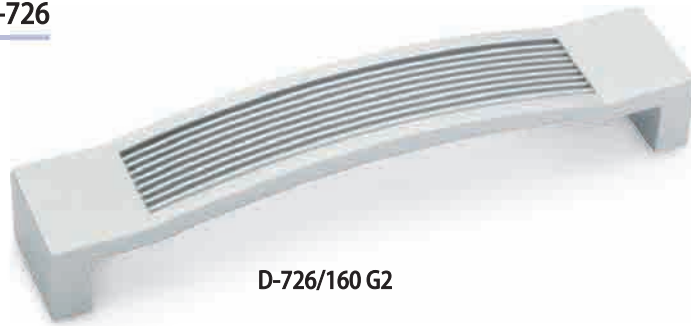

D-726/160 G2

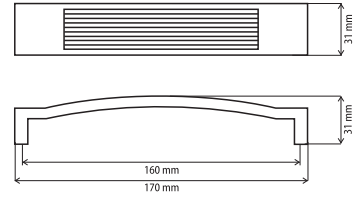

## D-725

	↔	△
D-725	160	G2
D-725	160	G3
D-725	160	G5
D-725	160	G6

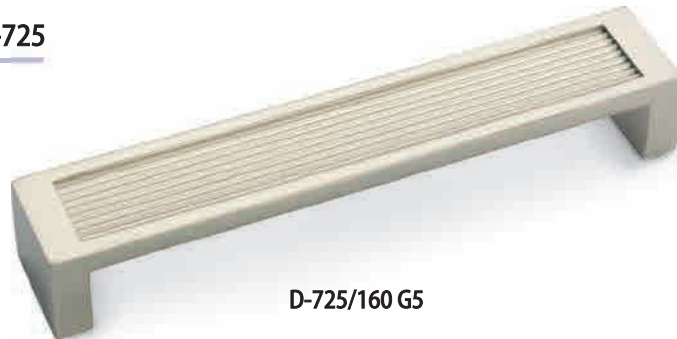

D-725/160 G5

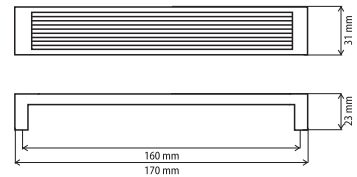

## K-725

	△
K-725	G2
K-725	G5



K-725/G2

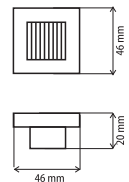



## D-714

Symbol	Value	Code
⤿	160	G2
↔	160	G5
△	160	G6
△	160	G7



D-714/160 G7

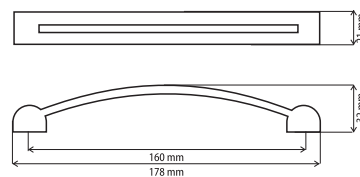

## D-715

Symbol	Value	Code
⤿	320	G2
↔	320	G3
△	320	G5
△	320	G6
⤿	160	G2
↔	160	G3
△	160	G5
△	160	G6



D-715/160 G3



## D-746

Symbol	Value	Code
⤿	320	G2
↔	320	G5
△	320	G6
⤿	160	G2
↔	160	G5
△	160	G6

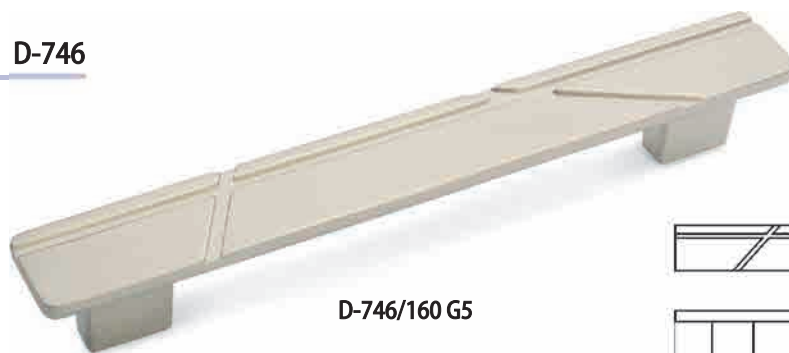

D-746/160 G5

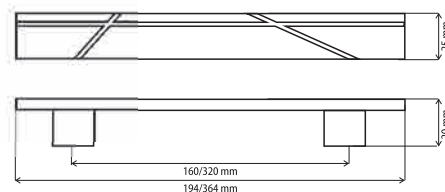

## DN 54

Symbol	Value	Code
⤿	128	G2
↔	128	G3
△	128	G5
△	128	G6



DN 54/128 G5

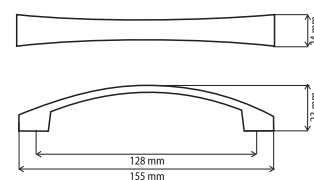

## DUG 14

Symbol	Value	Code
⤿	128	G6



DUG 14/128 G6

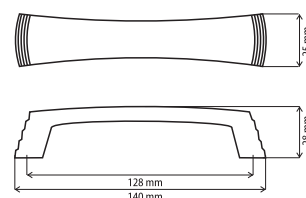



### D-703

⤿	↔	△
D-703	320	G2
D-703	320	G5
D-703	320	G6
D-703	192	G2
D-703	192	G5
D-703	192	G6
D-703	160	G2
D-703	160	G5
D-703	160	G6
D-703	128	G2
D-703	128	G5
D-703	128	G6
D-703	96	G2
D-703	96	G5
D-703	96	G6

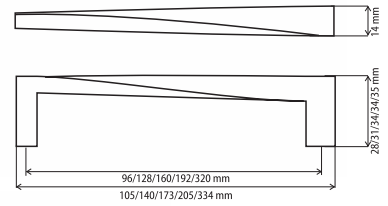
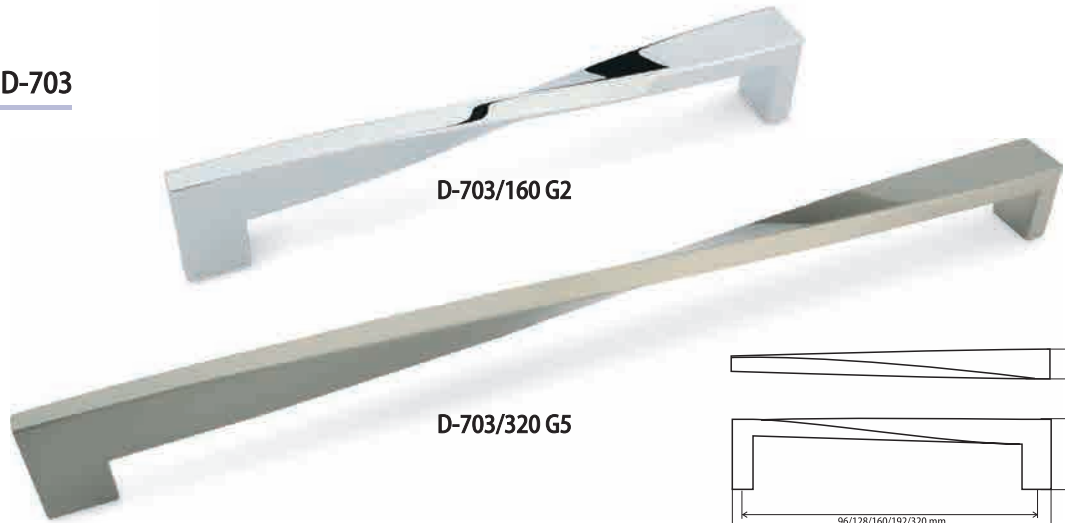

### D-709

⤿	↔	△
D-709	320	G2
D-709	320	G5
D-709	320	G6
D-709	320	G7

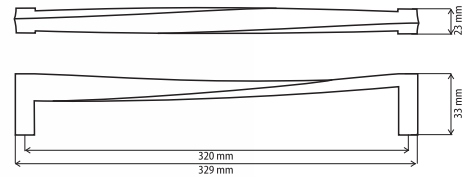

### D-730

⤿	↔	△
D-730	224	G2
D-730	224	G3
D-730	224	G5
D-730	224	G6

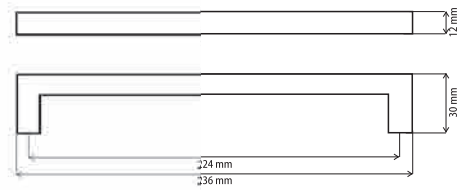

### D-705

⤿	↔	△
D-705	256	G2
D-705	256	G5
D-705	256	G6
D-705	224	G2
D-705	224	G5
D-705	224	G6

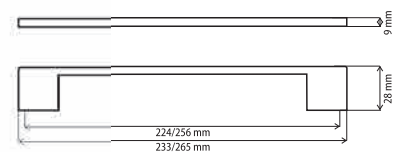

### D-706

	↔	△
D-706	320	G2
D-706	320	G5
D-706	320	G6
D-706	256	G2
D-706	256	G5
D-706	256	G6



D-706/256 G6

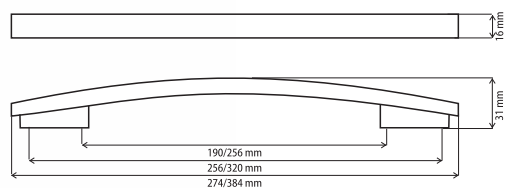

### D-708

	↔	△
D-708	320	G2
D-708	320	G5
D-708	320	G6
D-708	288	G2
D-708	288	G5
D-708	288	G6



D-708/288 G5

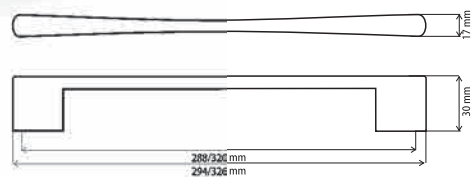

### D-731

	↔	△
D-731	320	G2
D-731	192	G2



D-731/192 G2

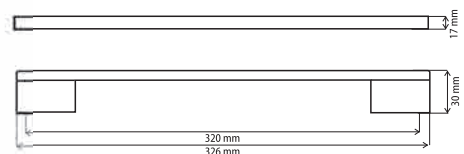

### D-734

	↔	△
D-734	448	AL
D-734	320	AL
D-734	256	AL
D-734	224	AL
D-734	192	AL
D-734	160	AL
D-734	128	AL
D-734	96	AL



D734/256 AL

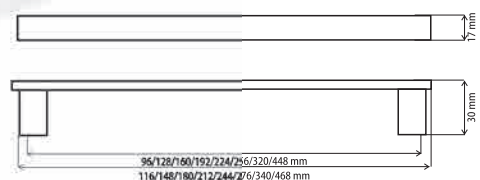

### D-707

	↔	△
D-707	256	G2
D-707	256	G5
D-707	256	G6



D-707/256 G5

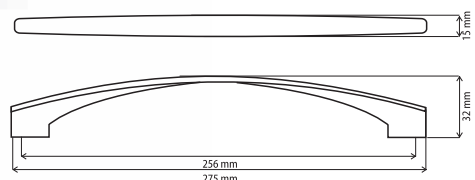





## D-732

	↔	△
D-732	160	G2
D-732	160	G5
D-732	160	G6



D-732/160 G2

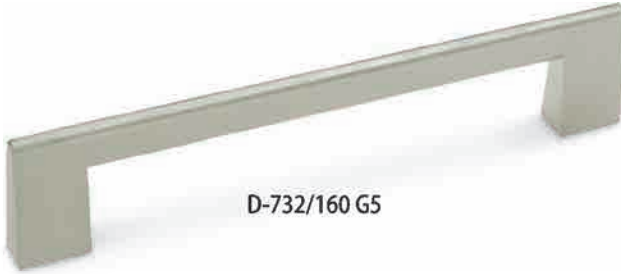

D-732/160 G5

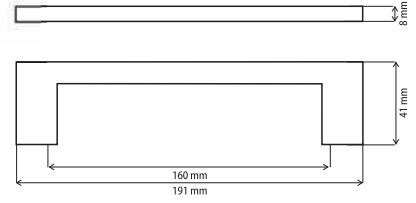

## DN 78

	↔	△
DN 78	128	G2
DN 78	128	G5
DN 78	96	G2
DN 78	96	G5



DN 78/128 G5

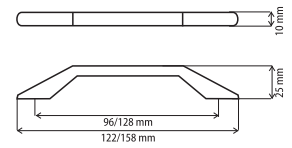

## D-710

	↔	△
D-710	160	G2
D-710	160	G5
D-710	160	G6



D-710/160 G2

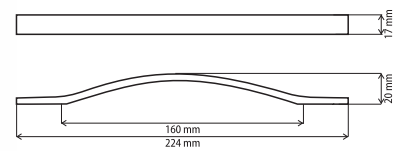

## D-704

	↔	△
D-704	320	G2
D-704	320	G5
D-704	320	G6
D-704	192	G2
D-704	192	G5
D-704	192	G6
D-704	128	G2
D-704	128	G5
D-704	128	G6



D-704/128 G5

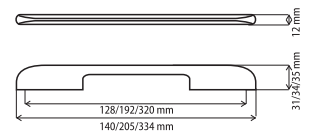

## DR 10

↖	↔	△	↖	↔	△
DR 10	672	G5	DR 10	288	G2
DR 10	576	G2	DR 10	288	G5
DR 10	576	G5	DR 10	288	G6
DR 10	576	G6	DR 10	256	G2
DR 10	544	G5	DR 10	256	G5
DR 10	512	G5	DR 10	256	G6
DR 10	480	G2	DR 10	224	G2
DR 10	480	G5	DR 10	224	G5
DR 10	480	G6	DR 10	224	G6
DR 10	448	G2	DR 10	224	G8
DR 10	448	G5	DR 10	192	G2
DR 10	448	G6	DR 10	192	G5
DR 10	448	G8	DR 10	192	G6
DR 10	416	G5	DR 10	192	G8
DR 10	416	G6	DR 10	160	G2
DR 10	384	G2	DR 10	160	G5
DR 10	384	G5	DR 10	160	G6
DR 10	384	G6	DR 10	160	G8
DR 10	352	G2	DR 10	128	G2
DR 10	352	G5	DR 10	128	G5
DR 10	352	G6	DR 10	128	G6
DR 10	352	G8	DR 10	128	G8
DR 10	320	G2	DR 10	96	G2
DR 10	320	G5	DR 10	96	G5
DR 10	320	G6	DR 10	96	G6
DR 10	320	G8	DR 10	96	G8

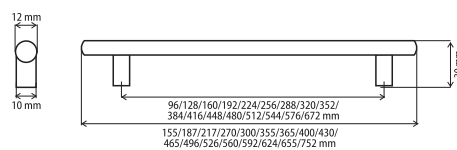
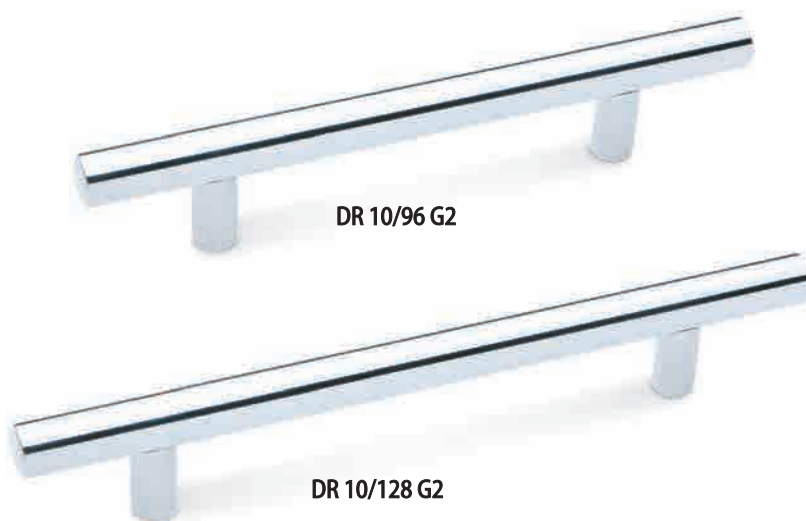

## UA 06

↖	↔	△	↔
UA 06	448	G5	G5
UA 06	448	G6	G6
UA 06	448	G8	G8
UA 06	224	G5	G5
UA 06	224	G6	G6
UA 06	224	G8	G8
UA 06	160	G5	G5
UA 06	160	G6	G6
UA 06	160	G8	G8
UA 06	128	G5	G5
UA 06	128	G6	G6
UA 06	128	G8	G8

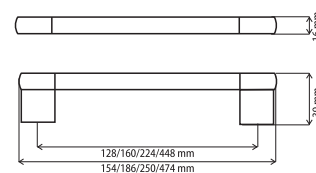

## D-761

↖	↔	△
D-761	160	AL
D-761	128	AL

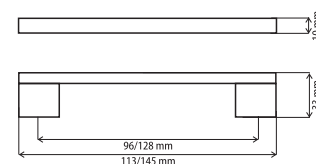
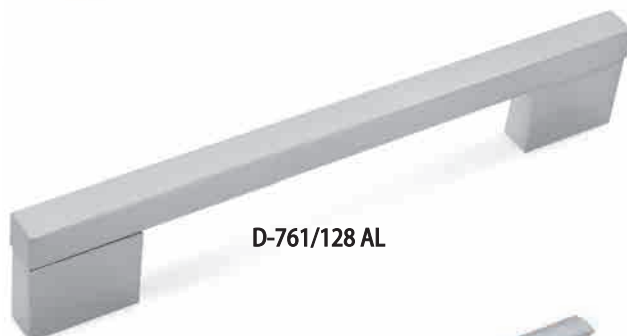

## DU 03

↖	↔	△
DU 03	224	AL
DU 03	192	AL
DU 03	160	AL
DU 03	128	AL
DU 03	96	AL

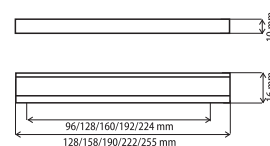
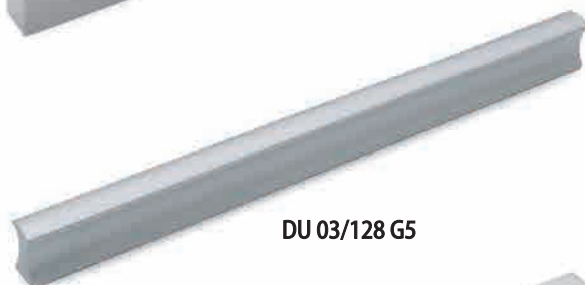

## DU 02

↖	↔	△
DU 02	224	AL
DU 02	160	AL
DU 02	128	AL
DU 02	96	AL

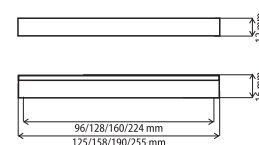
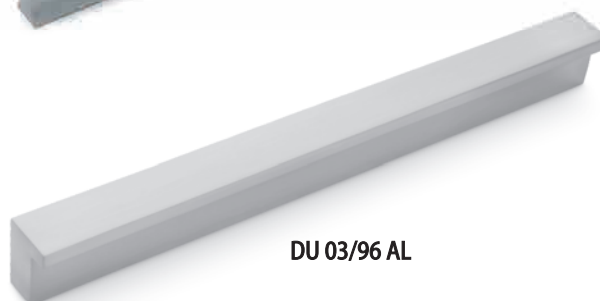



### D-740

D-740	192	G2	AL	
D-740	160	G2	AL	
D-740	128	G2	AL	



D-740/160 G2/AL

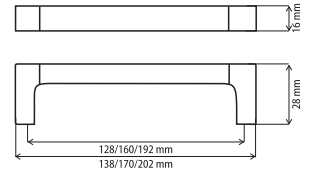

### DRU 09

DRU 09	192	G2	AL	
DRU 09	160	G2	AL	
DRU 09	128	G2	AL	



DRU 09/128 G2/AL

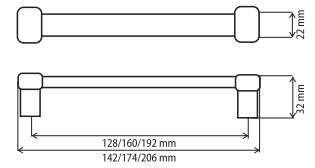

### DRU 08

DRU 08	192	G2	AL	
DRU 08	160	G2	AL	
DRU 08	128	G2	AL	



DRU 08/128 G2/AL

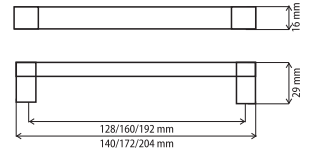

### DRU 20





DRU 20	192	G2	AL	
DRU 20	160	G2	AL	
DRU 20	128	G2	AL	
DRU 20	96	G2	AL	

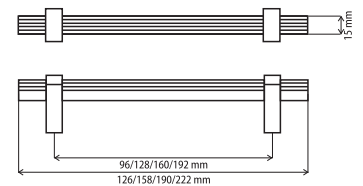
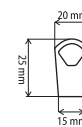

DRU 20/96 G2/AL



## D-712

			
D-712	256	G2	G6
D-712	192	G2	G6
D-712	160	G2	G6





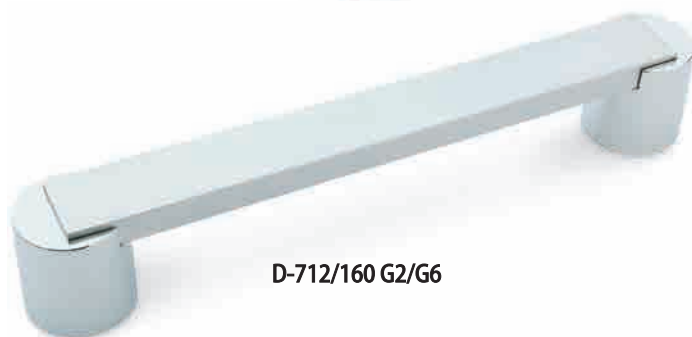

D-712/192 G2/G6

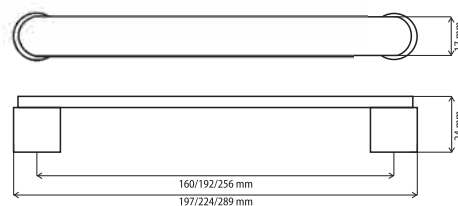

D-712/160 G2/G6



## D-755





			
D-755	160	G2	AL
D-755	128	G2	AL

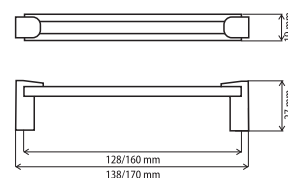

D-755/160 G2/AL



## D-756





			
D-756	160	G2	AL
D-756	128	G2	AL

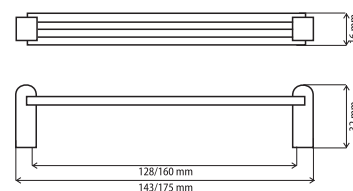

D-756/160 G2/AL



## D-720

			
D-720	448	G2	AL
D-720	320	G2	AL
D-720	224	G2	AL
D-720	160	G2	AL
D-720	192	G2	AL





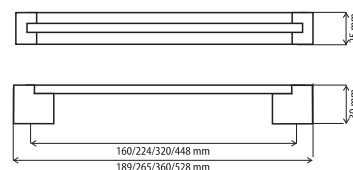

D-720/160 G2/AL









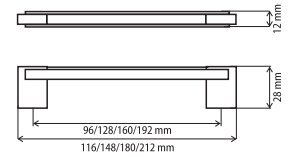

## D-450

				
D-450	192	G2	OS	
D-450	192	G2	D12	
D-450	160	G2	OS	
D-450	160	G2	D12	
D-450	128	G2	OS	
D-450	128	G2	D12	
D-450	96	G2	OS	
D-450	96	G2	D12	



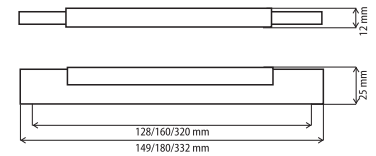

## D-748

				
D-748	320	G6	D8	
D-748	160	G6	D8	
D-748	128	G6	D8	





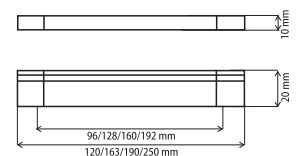

## D-752

				
D-752	192	AL	D12	
D-752	160	AL	D12	
D-752	128	AL	D12	
D-752	96	AL	D12	



## DK 20





			
DK 20	128	G5	K37 ZF
DK 20	128	G6	K32 PF
DK 20	128	G6	K33 PF
DK 20	128	G6	K35 PF
DK 20	128	G6	K37 PF
DK 20	128	G6	K37 ZF
DK 20	128	G6	K34 PF

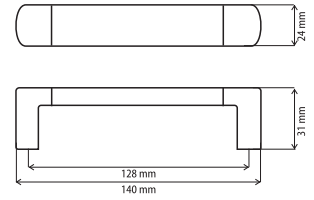

DK 20/128 G6/K33



## DK 30





			
DK 30	128	G5	K37

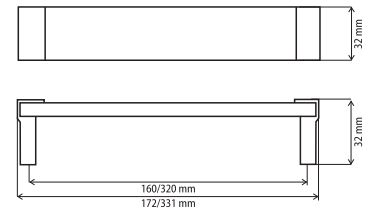

DK 30/128 G5/K37



## D-751

			
D-751	320	G2	Glass
D-751	320	G6	Glass
D-751	160	G2	Glass
D-751	160	G6	Glass





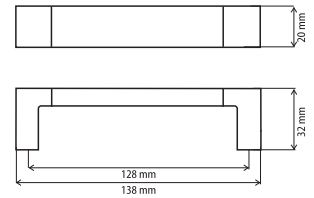

D-751/160 G6/Glass







## DU 08



				
DU 08	224	G2	AL	
DU 08	224	G5	AL	
DU 08	224	G6	AL	
DU 08	192	G2	AL	
DU 08	192	G5	AL	
DU 08	192	G6	AL	
DU 08	160	G2	AL	
DU 08	160	G5	AL	
DU 08	160	G6	AL	
DU 08	128	G2	AL	
DU 08	128	G5	AL	
DU 08	128	G6	AL	
DU 08	96	G2	AL	
DU 08	96	G5	AL	
DU 08	96	G6	AL	

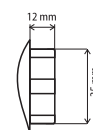
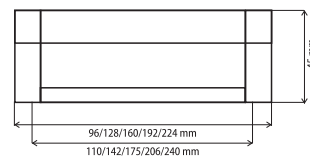

DU 08/128 G5/AL



## D-701





			
D-701	160	G9	

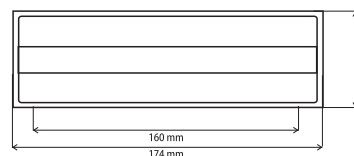

D-701/160 G9



## D-717



				
D-717	160	G2	AL	
D-717	128	G2	AL	
D-717	96	G2	AL	

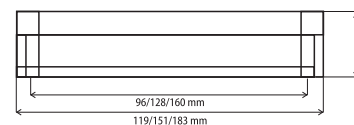

D-717/128 G2/AL



## DN 50

			
DN 50	128	G2	
DN 50	128	G3	
DN 50	128	G5	
DN 50	128	G6	
DN 50	96	G2	
DN 50	96	G3	
DN 50	96	G5	
DN 50	96	G6	



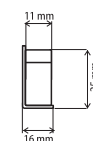
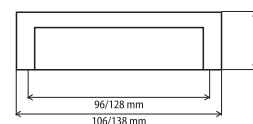

DN 50/128 G5







## D-741





			
D-741	160	G2	
D-741	160	G5	
D-741	160	G6	
D-741	128	G2	
D-741	128	G5	
D-741	128	G6	

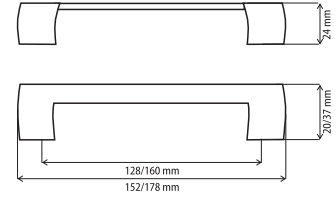

D-741/128 G2



## D-750

				
D-750	192	G2	AL	
D-750	160	G2	AL	
D-750	128	G2	AL	



D-750/128 G2/AL

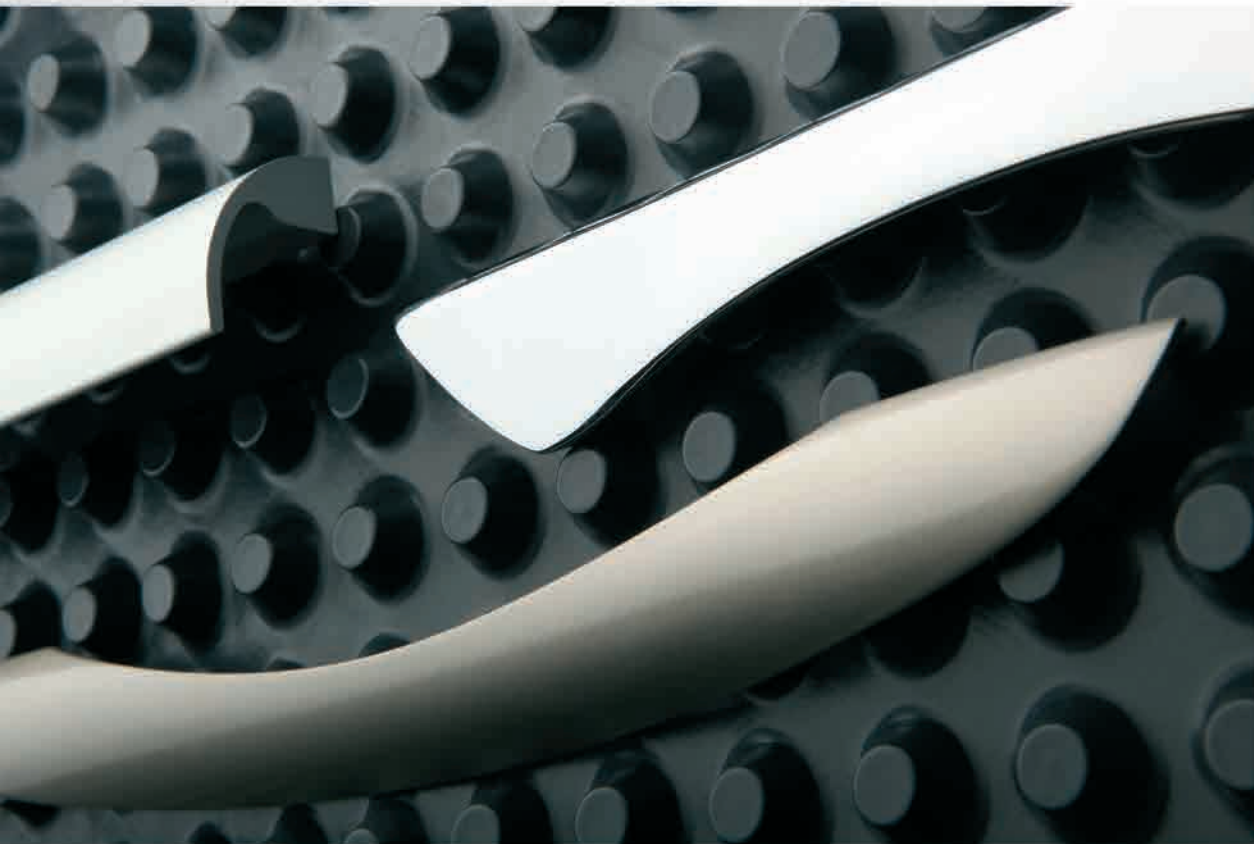
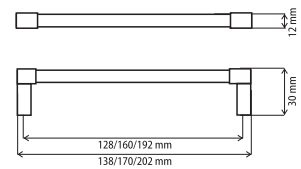

## D-747

	↔	△	LR
D-747	160	G2	L
D-747	160	G5	L
D-747	160	G6	L
D-747	160	G2	R
D-747	160	G5	R
D-747	160	G6	R



D-747/160 G2 R

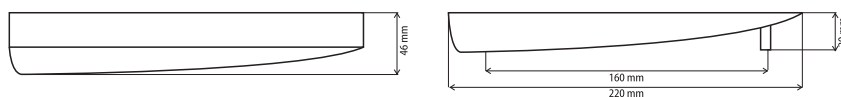

## DU 01

	↔	△
DU 01	448	AL
DU 01	192	AL
DU 01	160	AL
DU 01	128	AL
DU 01	96	AL

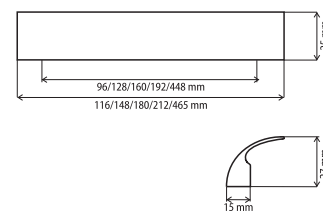
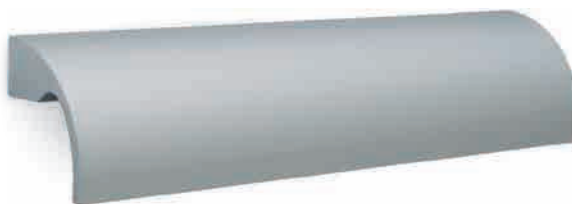

DU 01/128 AL

## D-716

	↔	△
D-716	160	G2



D-716/160 G2

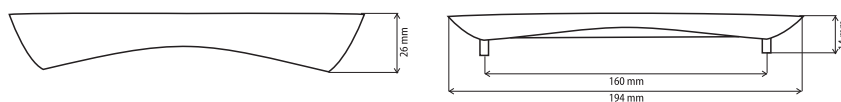

## D-702

	↔	△
D-702	192	G2
D-702	192	G5
D-702	192	G6



D-702/192 G6

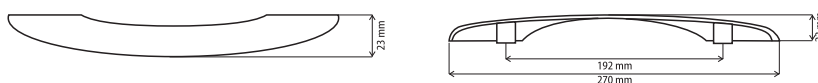



## K-702

K-702	64	G2
K-702	64	G6
K-702	32	G2
K-702	32	G6



K-702/64 G6



K-702/32 G6

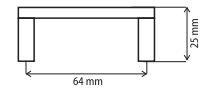
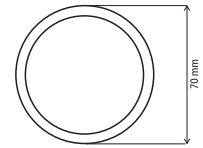
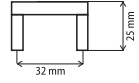
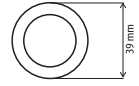

## K-704

K-704	16	G2	G8
K-704	32	G6	G8



K-704/16 G2/G8



K-704/32 G6/G8

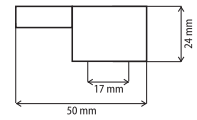
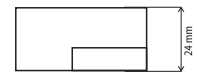

## D-069

D-069	32	G2



D-069/32 G2

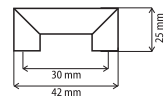

**K-728  
K-729**

☐	△
K-728	G2
K-728	G5
K-728	G6
K-728	G9
K-729	G2
K-729	G5
K-729	G6
K-729	G9



**K-729/G5**



**K-728/G5**

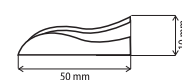
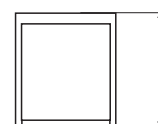
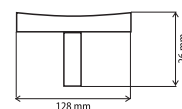
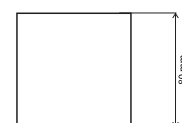
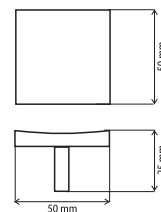

**K-705**

☐	△
K-705	G5



**K-705/G5**

**K-700  
K-701**

☐	△
K-700	G2
K-700	G5
K-701	G2
K-701	G5



**K-701/G2**



**K-700/G2**

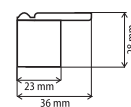
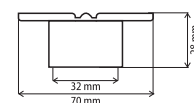
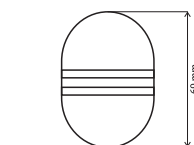

**DD 12  
DGA 27**

☐	△
DD 12	G2
DD 12	G3
DD 12	G5
DGA 27	G2
DGA 27	G3
DGA 27	G5



**DGA 27/G5**



**DD 12/G2**









# Классик



52-69

## Классик - Classic

Эпоха рококо в XVIII в. постепенно начала сдавать свои позиции в Европе. На смену ей пришел самый спокойный из «королевских стилей» - стиль классицизма, который был возвращением к античности, но уже с учетом возможностей времени. Удачное сочетание спокойных античных мотивов и изогнутых линий рококо - это основная тенденция времени. Стиль мебельных ручек классицизма холодный, благодаря строгим формам и торжественный, благодаря позолоте.

## DN 87 DGA 28

		
DN 87	128	G2
DN 87	128	G3
DN 87	128	G5
DN 87	128	G6
DN 87	96	G2
DN 87	96	G3
DN 87	96	G5
DN 87	96	G6

	
DGA 28	G2
DGA 28	G3
DGA 28	G5
DGA 28	G6



DN 87/128 G2



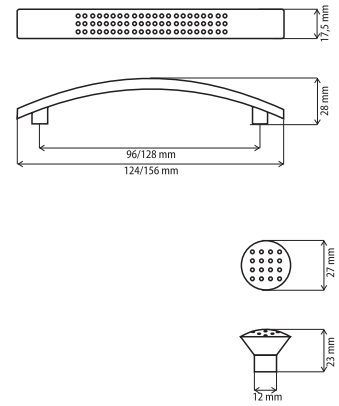

DN 87/96 G2



DGA/28 G5

## DN 88 DG 66

		
DN 88	128	G1/C
DN 88	128	G2
DN 88	128	G4
DN 88	128	G5
DN 88	128	G3
DN 88	128	G6
DN 88	96	G1/C
DN 88	96	G2
DN 88	96	G4
DN 88	96	G5
DN 88	96	G3
DN 88	96	G6

	
DG 66	G2
DG 66	G3



DN 88/96 G5



DN 88/128 G1/C

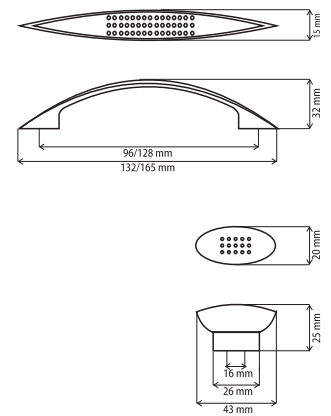

DG 66/G5



**DRR 08  
DR 08**

	↔	△
DRR 08	160	G2
DRR 08	160	G3
DRR 08	160	G5
DRR 08	160	G6
DRR 08	160	G8
DRR 08	128	G2
DRR 08	128	G3
DRR 08	128	G5
DRR 08	128	G6
DRR 08	128	G8
DRR 08	96	G2
DRR 08	96	G3
DRR 08	96	G5
DRR 08	96	G6
DRR 08	96	G8

⌋	△
DR 08	G2
DR 08	G5
DR 08	G6



**DRR 08/128 G5**



**DR 08/G5**

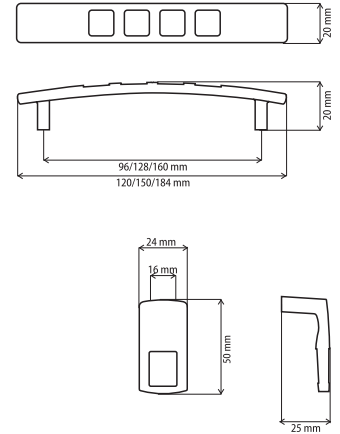

**D-434  
D-433  
DG 059**

	↔	△
D-434	128	G2
D-434	128	G3
D-434	128	G5
D-433	96	G2
D-433	96	G3
D-433	96	G5

⌋	△
DG 059	G2
DG 059	G3
DG 059	G5



**D-434/128 G3**



**D-433/96 G5**



**DG 059/G5**

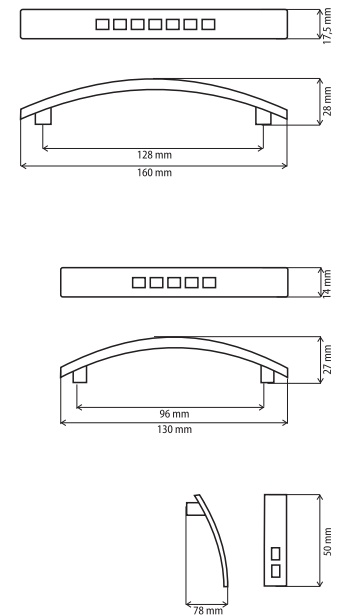

**D-664  
D-663  
DG 295**

D-664	128	G1/C
D-664	128	G2
D-664	128	G3
D-664	128	G5
D-664	128	G6
D-663	96	G1/C
D-663	96	G2
D-663	96	G3
D-663	96	G5
D-663	96	G6

DG 295	G2
DG 295	G3
DG 295	G5



**D-664/128 G5**

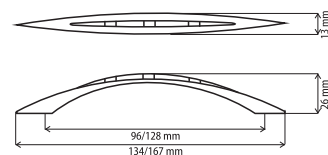

**D-663/96 G5**



**DG 295/G5**

**DN 49  
DG 02**

DN 49	128	G2
DN 49	128	G3
DN 49	128	G5

DG 02	G2
DG 02	G3
DG 02	G5



**DN 49/128 G2**

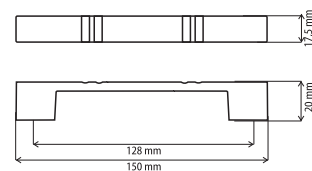

**DG 02/G5**

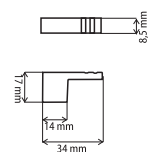

**DUG 20**

DUG 20	96	G2
DUG 20	96	G5



**DUG 20/96 G2**

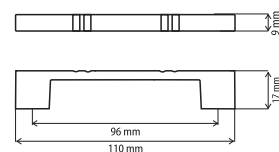





## DN 44

↪	↔	△
DN 44	128	G2
DN 44	128	G3
DN 44	128	G5
DN 44	96	G2
DN 44	96	G3
DN 44	96	G5

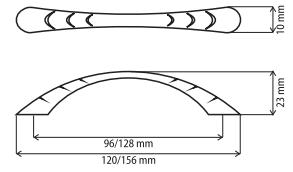
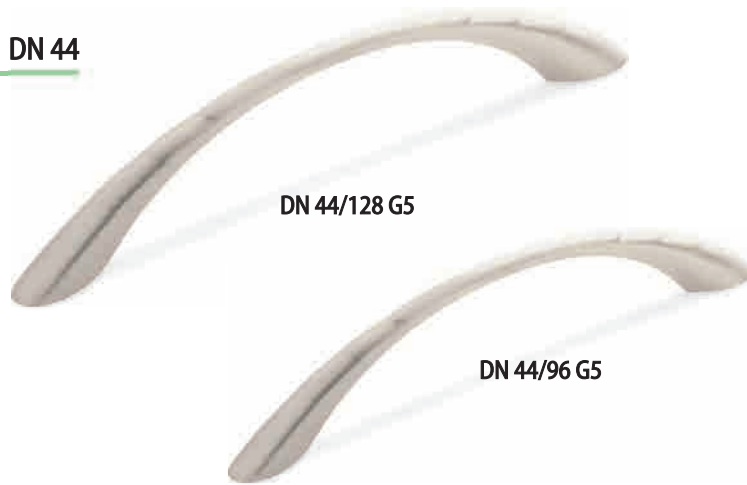

## DN 83

↪	↔	△
DN 83	128	G1/C
DN 83	128	G2
DN 83	128	G3
DN 83	128	G5
DN 83	128	G6
DN 83	96	G1/C
DN 83	96	G2
DN 83	96	G3
DN 83	96	G5
DN 83	96	G6
DN 83	64	G2
DN 83	64	G3
DN 83	64	G5

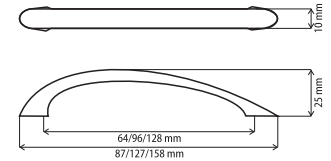

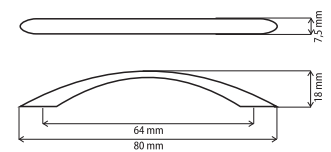
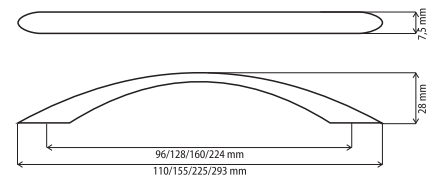
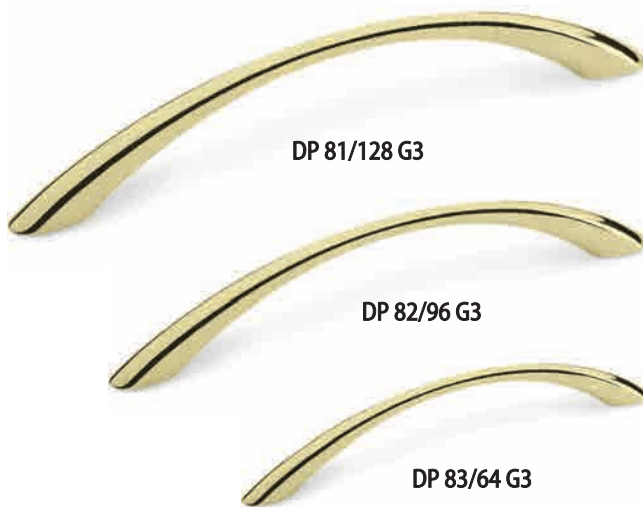

## DP 81 DP 82 DP 83

↪	↔	△
DP 81	128	G1
DP 81	128	G1/C
DP 81	128	G2
DP 81	128	G3
DP 81	128	G5
DP 81	128	G6
DP 81	128	G8
DP 81	128	P9
DP 82	96	G1
DP 82	96	G1/C
DP 82	96	G2
DP 82	96	G3
DP 82	96	G4
DP 82	96	G5
DP 82	96	G6
DP 82	96	G8
DP 82	96	P9
DP 83	64	G2
DP 83	64	G3
DP 83	64	G5
DP 83	64	P9
DP 84	224	G2
DP 84	224	G3
DP 84	224	G5
DP 85	160	G2
DP 85	160	G5



## DS 05



		
DS 05	96	G2
DS 05	96	G3
DS 05	96	G5

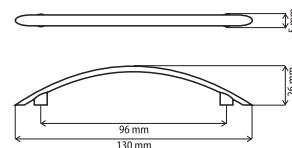

DS 05/96 G2



## DS 24



		
DS 24	128	G2
DS 24	128	G5
DS 24	96	G2
DS 24	96	G5

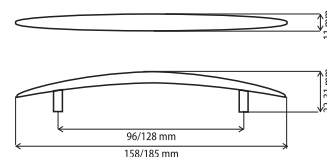

DS 24/96 G2



## DN 43

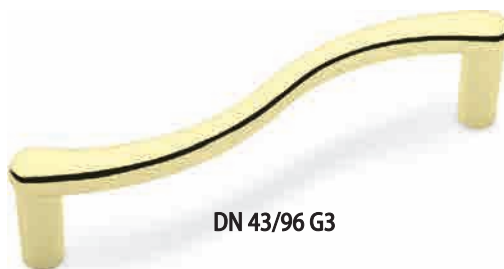

		
DN 43	128	G2
DN 43	128	G3
DN 43	128	G5
DN 43	96	G2
DN 43	96	G3
DN 43	96	G5
DN 43	96	G6

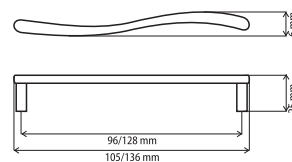

DN 43/96 G3



## DP 38



		
DP 38	128	G2
DP 38	128	G3
DP 38	128	G5

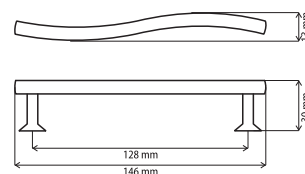

DP 38/128 G3



## DN 11 DN 12

		
DN 11	128	G2
DN 11	128	G3
DN 11	128	G5
DN 12	96	G2
DN 12	96	G3
DN 12	96	G5



DN 11/128 G5

DN 12/96 G5

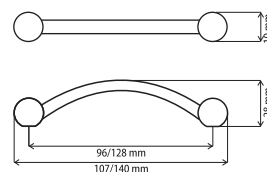



## DS 27

↪	↔	△
DS 27	96	G2
DS 27	96	G3
DS 27	96	G5
DS 27	96	P9

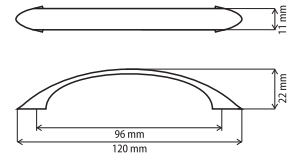

## DN 92

↪	↔	△
DN 92	128	G2
DN 92	128	G3
DN 92	128	G5
DN 92	96	G2
DN 92	96	G3
DN 92	96	G5
DN 92	96	G6
DN 92	64	G2
DN 92	64	G3
DN 92	64	G5

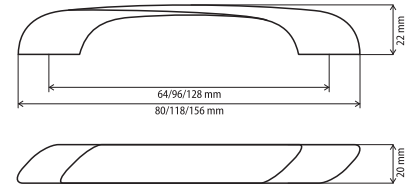

## DS 26

↪	↔	△
DS 26	128	G1
DS 26	128	G1/C
DS 26	128	G2
DS 26	128	G3
DS 26	128	G5
DS 26	128	G6
DS 26	128	P9
DS 26	96	G1
DS 26	96	G1/C
DS 26	96	G2
DS 26	96	G3
DS 26	96	G5
DS 26	96	G6
DS 26	96	P9

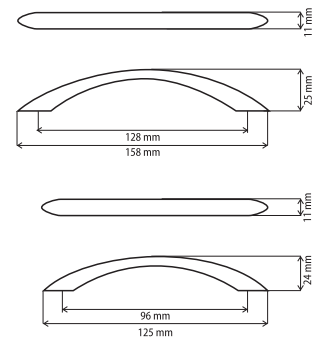
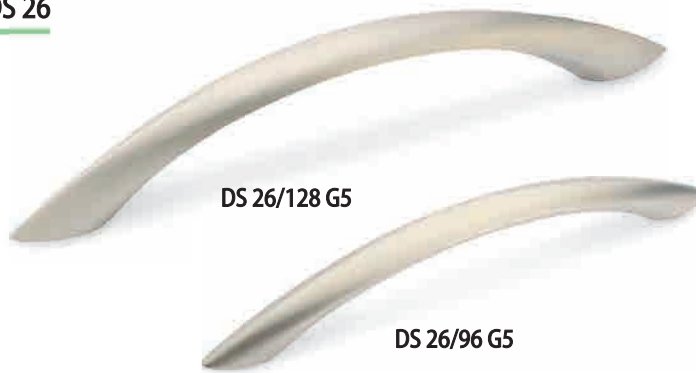

## DS 09

↪	↔	△
DS 09	96	G2
DS 09	96	G3
DS 09	96	G5
DS 09	96	P9

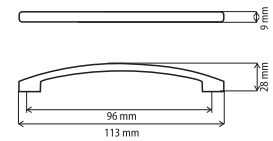

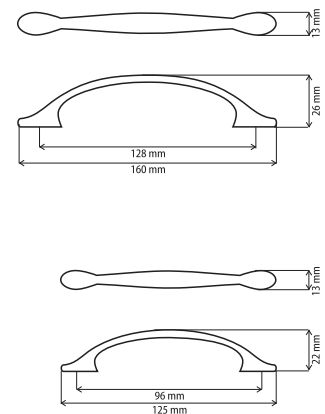

## SS 6528 SS 6526

↪	↔	△
SS 6528	128	G2
SS 6528	128	G5
SS 6526	96	G2
SS 6526	96	G5



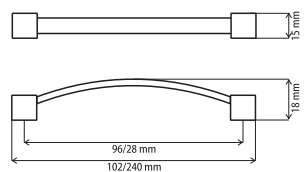

## DN 96

			
DN 96	128		G2
DN 96	128		G3
DN 96	128		G5
DN 96	96		G2
DN 96	96		G3
DN 96	96		G5



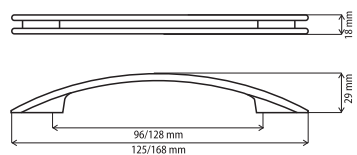
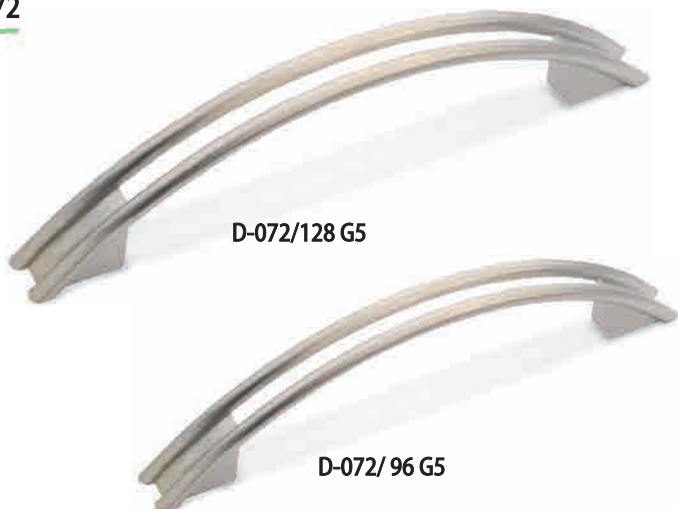

## D-072

			
D-072	128		G2
D-072	128		G3
D-072	128		G5
D-072	96		G2
D-072	96		G3
D-072	96		G5



## DN 98

			
DN 98	128		G5
DN 98	96		G2
DN 98	96		G3
DN 98	96		G5

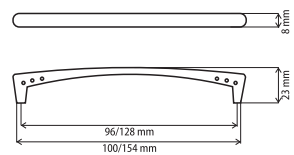
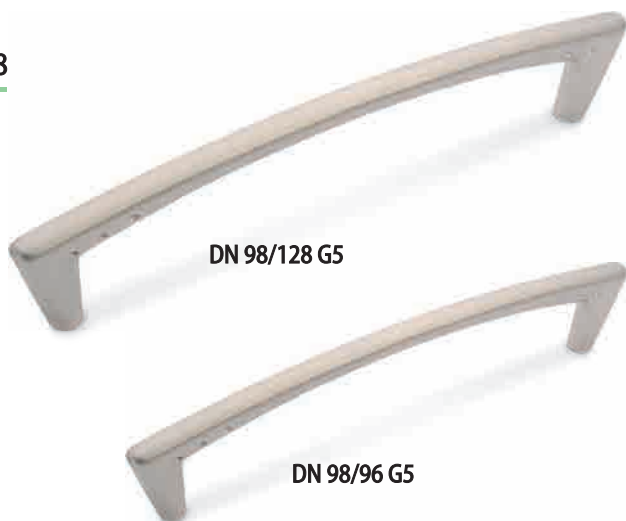





### D-071

↷	↔	△
D-071	128	G2
D-071	128	G3
D-071	128	G5
D-071	96	G2
D-071	96	G3
D-071	96	G5
D-071	96	G6



D-071/128 G2



D-071/96 G2

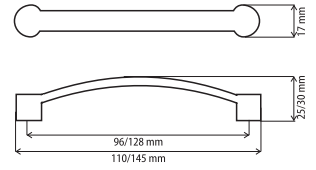

### DN 13 DN 14

↷	↔	△
DN 13	128	G2
DN 13	128	G3
DN 13	128	G5
DN 14	96	G2
DN 14	96	G3
DN 14	96	G5



DN 13/128 G5



DN 14/96 G5

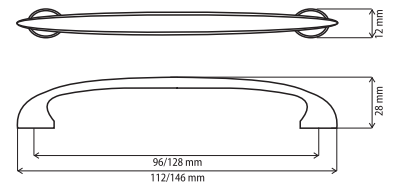

### DN 18 DN 17

↷	↔	△
DN 17	128	G2
DN 17	128	G3
DN 17	128	G5
DN 18	96	G2
DN 18	96	G3
DN 18	96	G5



DN 18/96 G3



DN 17/128 G3

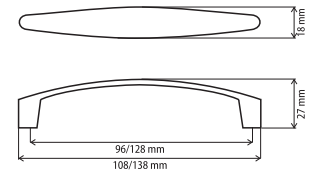

## DN 81

↷	↔	△
DN 81	128	G2
DN 81	128	G3
DN 81	128	G5



DN 81/128 G2

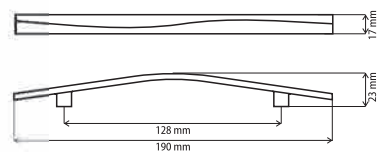

## DN 90

↷	↔	△
DN 90	128	G2
DN 90	128	G3
DN 90	128	G5
DN 90	128	G6
DN 90	128	G8
DN 90	96	G2
DN 90	96	G3
DN 90	96	G5
DN 90	96	G6



DN 90/128 G5

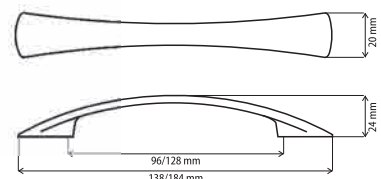

DN 90/96 G2

## DN 06

↷	↔	△
DN 06	96	G2
DN 06	96	G3
DN 06	96	G5
DN 06	96	G6



DN 06/ 96 G2

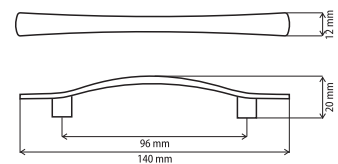

## D-003

↷	↔	△
D-003	128	G2
D-003	128	G3
D-003	128	G5



D-003/128 G2

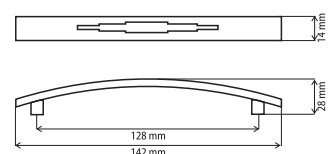



## D-001

	↔	△
D-001	192	G2
D-001	192	G3
D-001	192	G5
D-001	192	G6
D-001	128	G2
D-001	128	G3
D-001	128	G5
D-001	128	G6
D-001	96	G2
D-001	96	G3
D-001	96	G5
D-001	96	G6



D-001/128 G3

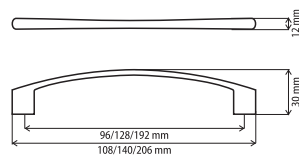

## DN 89

	↔	△
DN 89	96	G2
DN 89	96	G3
DN 89	96	G5
DN 89	64	G2
DN 89	64	G3
DN 89	64	G5



DN 89/64 G3



DN 89/96 G2

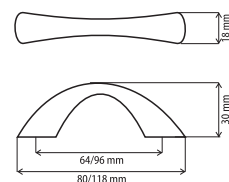

## D-070

	↔	△
D-070	32	G2
D-070	32	G3
D-070	32	G5



D-070/32 G3

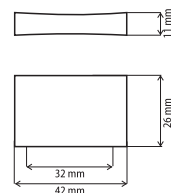

## DS 29 DUU 39

	↔	△
DS 29	96	G2
DS 29	96	G3
DS 29	96	G5
DUU 39	96	G2
DUU 39	96	G3
DUU 39	96	G5
DUU 39	96	G6



DUU 39/96 G2



DS 29/96 G3

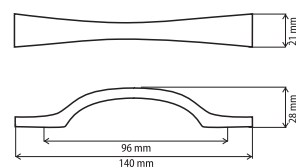
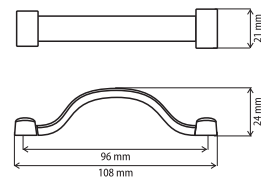





## D-800

Symbol	Length	Finish
⤿	448	G5
↔	448	G6
△	320	G5
⤿	320	G6
↔	224	G5
△	224	G6
⤿	192	G5
↔	192	G6
△	160	G5
⤿	160	G6
↔	128	G5
△	128	G6

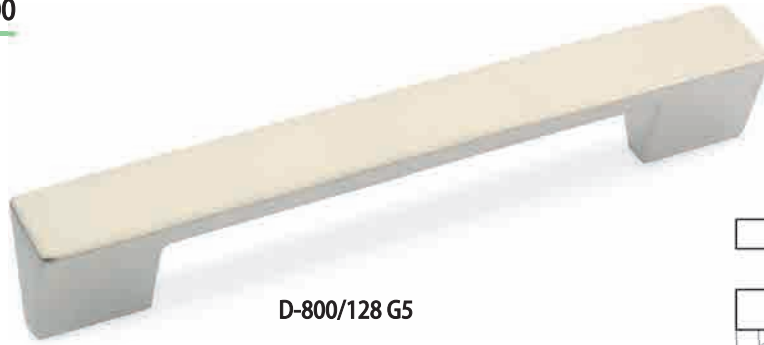

D-800/128 G5

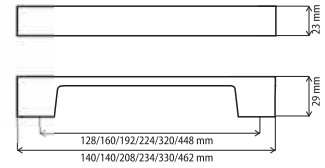

## DUU 71

Symbol	Length	Finish
⤿	192	G2
↔	192	G5
△	192	G6
⤿	160	G2
↔	160	G5
△	160	G6

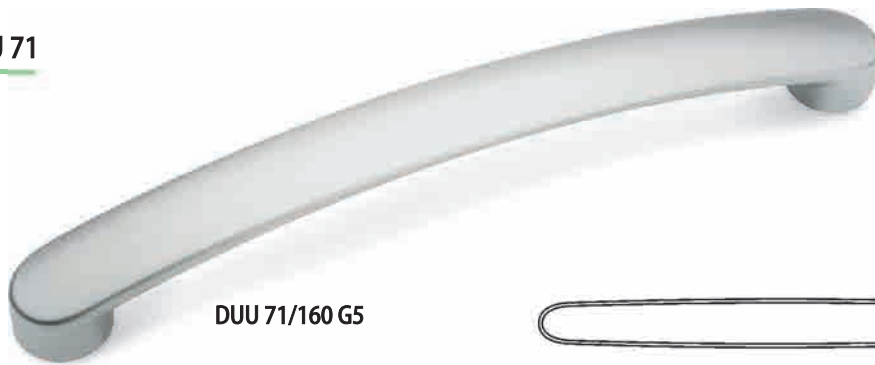

DUU 71/160 G5

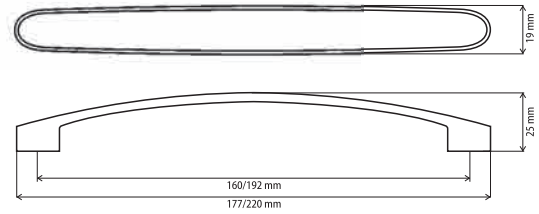

## D-002

Symbol	Length	Finish
⤿	128	G2
↔	128	G3
△	128	G5
⤿	128	G6



D-002/128 G5

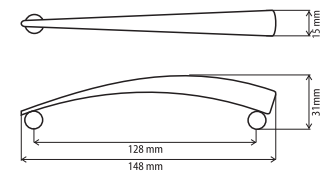

## DN 97

Symbol	Length	Finish
⤿	160	G2
↔	160	G3
△	160	G5
⤿	128	G2
↔	128	G3
△	128	G5



DN 97/128 G5

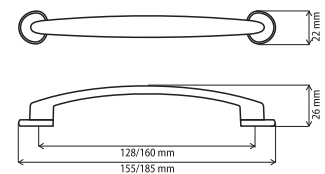

## DUU 36

DUU 36	160	G5
DUU 36	128	G5
DUU 36	96	G5

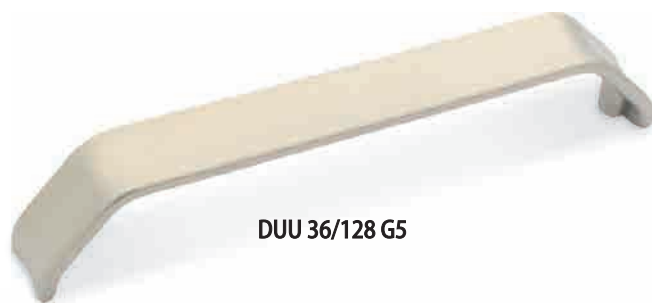

DUU 36/128 G5

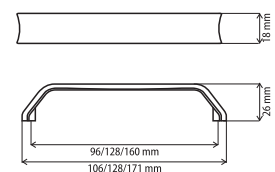

## DN 94

DN 94	128	G2
DN 94	128	G5
DN 94	128	G6



DN 94/128 G5

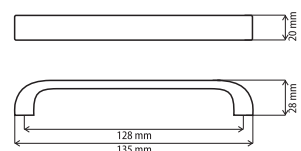

## DU 04

DU 04	320	AL
DU 04	192	AL
DU 04	160	AL
DU 04	128	AL



DU 04/128 AL

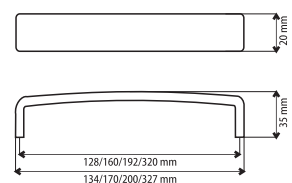

## DN 45

DN 45	128	G2
DN 45	128	G3
DN 45	128	G5
DN 45	96	G2
DN 45	96	G3
DN 45	96	G5



DN 45/128 G5

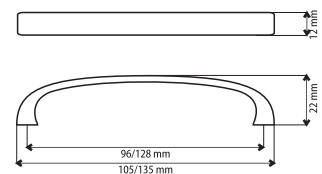

## DUU 21

DUU 21	128	G2
DUU 21	128	G5
DUU 21	128	G6
DUU 21	96	G2
DUU 21	96	G5
DUU 21	96	G6



DUU 21/96 G6

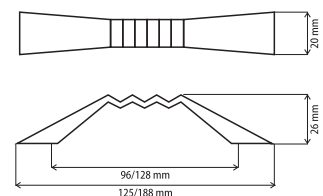

## DT 40

DT 40	128	G2
DT 40	128	G3
DT 40	128	G5
DT 40	96	G2
DT 40	96	G3
DT 40	96	G5



DT 40/96 G5

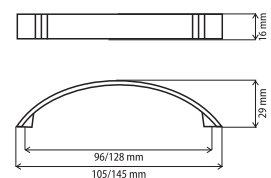



### D-200

D-200	128	G2	D6
D-200	128	G2	D30
D-200	128	G2	D19
D-200	128	G5	D6
D-200	128	G5	D30
D-200	128	G5	D19



D-200/128 G2/D8

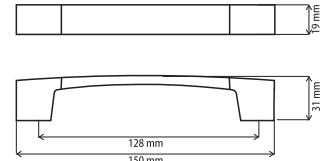

### DF 88 DF 19 DG 256

DF 19	128	G2	D6
DF 19	128	G2	D28
DF 19	128	G2	D30
DF 19	128	G3	D6
DF 19	128	G5	D6
DF 19	128	G5	D28
DF 19	128	G5	D7
DF 19	128	G5	D30
DF 88	96	G2	D6
DF 88	96	G3	D6
DF 88	96	G5	D6



DF 19/128 G3/D6



DG 256 G2/D6

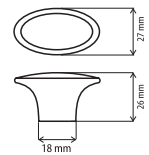
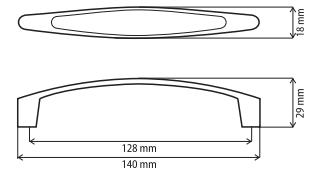
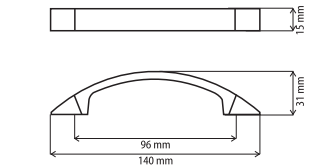

DG 256	G2	D6
DG 256	G5	D6



DF 88/96 G2/D6

### D-473

D-473	96	K10
D-473	96	K6
D-473	96	G3
D-473	96	K8
D-473	96	K11



D-473/96 K11

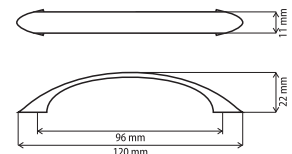

### D-210 D-215

D-210	128	G6
D-215	128	G6



D-210/128 G6



D-215/128 G6

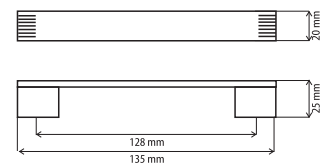

## DD 10

☞	↔	△
DD 10	96	D7
DD 10	96	D6
DD 10	96	D4
DD 10	96	D8
DD 10	96	D28
DD 10	96	D9
DD 10	96	D29



DD 10/96 D7

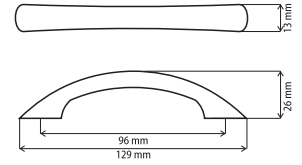

## KD 10L KD 10S

☞	△	☞	△
KD 10S	D7	KD 10S	D7
KD 10S	D4	KD 10S	D4
KD 10S	D6	KD 10S	D6
KD 10S	D8	KD 10S	D8
KD 10S	D28	KD 10S	D28
KD 10S	D9	KD 10S	D9
KD 10S	D29	KD 10S	D29
KD 10S	K10	KD 10S	K10
KD 10S	K11	KD 10S	K11



KD 10L D8



KD 10S D8

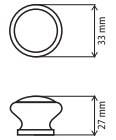





**DGA 09  
DG 16**

☐	△
DGA 09	G2
DGA 09	G3
DGA 09	G5
DG 16	G2
DG 16	G3
DG 16	G5



**DGA 09 G2**



**DG 16 G5**

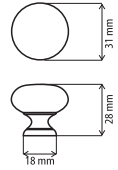
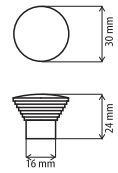

**DG 32  
DG 33  
DG 09**

☐	△
DG 32	G2
DG 32	G3
DG 32	G5
DG 33	G2
DG 33	G3
DG 33	G5
DG 09	G2
DG 09	G3
DG 09	G5
DG 09	G6



**DG 33 G3**



**DG 32 G5**

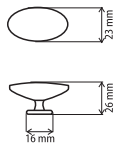
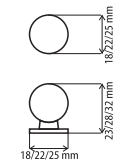

**DG 09 G5**



**DG 246 G5**

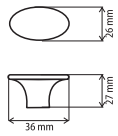
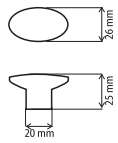

**DG 07  
DG 246**

☐	△
DG 07	G2
DG 07	G3
DG 07	G5
DG 07	G6
DG 246	G2
DG 246	G3
DG 246	G5



**DG 07 G2**

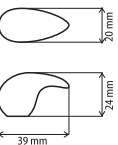
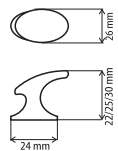

**DG 29  
DGA 20  
DG 01**

☐	△
DG 29	G2
DG 29	G3
DG 29	G5
DGA 20	G2
DGA 20	G3
DGA 20	G5
DG 01	G2
DG 01	G5



**DG 29 G5**



**DGA 20 G5**

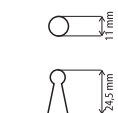
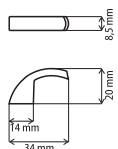

**DG 01 G5**

## DD 61

☰	△
DD 61	K6
DD 61	K28
DD 61	K3
DD 61	G2
DD 61	G3
DD 61	G5
DD 61	K4
DD 61	K8
DD 61	K11
DD 61	K10



DD 61 G2



DD 61 K6

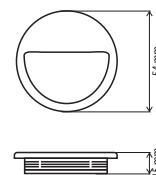

## DD 01 DD 02

☰	△
DD 01	G2
DD 01	G3
DD 01	G5
DD 02	G2
DD 02	G3
DD 02	G5



DD 01/G3



DD 02/G5

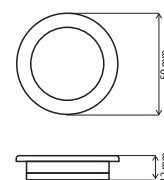

## DN 01

☰	△
DN 01	G2
DN 01	G3
DN 01	G5



DN 01/G3

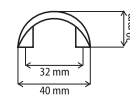

# Игрушки



## Ручки детские - Kid's handles

Вне стилей и направлений. Дизайн детских ручек веселый и беззаботный, простой и понятный. Ребенок познает мир. Задорный и солнечный подсолнух или нежная роза. Практически живые фрукты, овощи, ягоды в интерьере позволят малышу быстро и легко запомнить новые названия. А в забавных ручках в форме животных - можно угадывать настроение, с которым слон или медвежонок наблюдают за вами.



Медвежонок  
Слон



Медвежонок



Слон

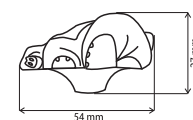
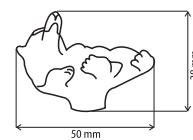
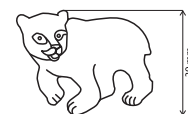

Панда  
Зайчик



Панда



Зайчик

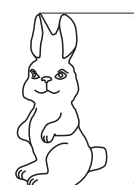

Бабочка  
Цикада



Бабочка



Цикада

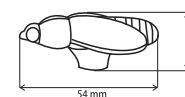
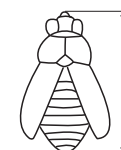
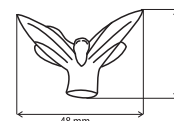





Рыбка желтая  
Рыбка красная  
Рыбка голубая



Рыбка желтая



Рыбка красная



Рыбка голубая

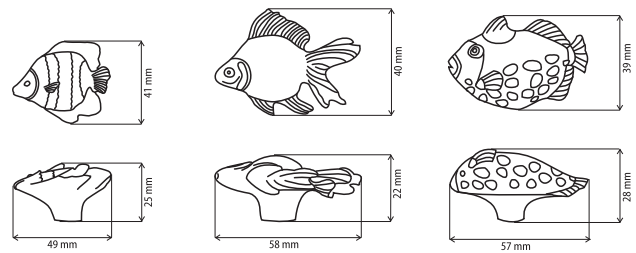

Морская звезда  
Черепашка



Черепашка

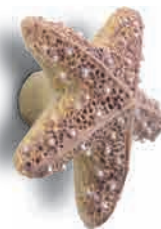

Морская звезда

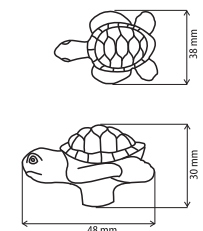
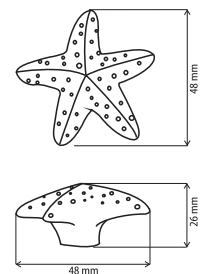



**Роза**  
**Подсолнух**



**Роза**



**Подсолнух**

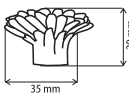
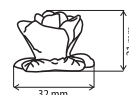

**Клубника**



**Клубника**

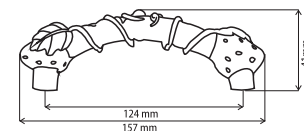



# Керамика

Керамика - Ceramic

Деревенский стиль в интерьере - кантри, характеризуется уютностью, комфортностью и долей романтизма. Французское кантри - прованс, которому свойственна пастельная гамма с яркими цветовыми акцентами. Мебель в стиле прованс обязательно старая или состаренная. Особое внимание уделяется оформлению интерьера - льняные скатерти, салфетки, и, конечно же, коллекция деревенской керамики, идеально сочетающаяся с керамическими ручками и цветочным орнаментом.

## DP 19

	↔	△	—
DP 19	96	AB	01M
DP 19	96	AB	02M
DP 19	96	AB	03M
DP 19	96	AB	05M
DP 19	96	AB	06M
DP 19	96	AB	07M



DP 19/96 G4/01M



DP 19/96 G4/02M



DP 19/96 G4/03M



DG 20 01M



DG 20 02M



DG 20 03M

## DG 20

	—
DG 20	01M
DG 20	02M
DG 20	03M
DG 20	05M
DG 20	06M
DG 20	07M



DP 19/96 G4/05M



DG 20 05M



DP 19/96 G4/06M



DG 20 06M



DP 19/96 G4/07M





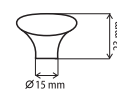
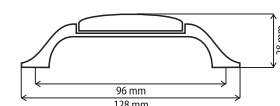

DG 20 07M







**DP 21**

				
DP 21	96	AB		01M
DP 21	96	AB		02M
DP 21	96	AB		03M
DP 21	96	AB		05M
DP 21	96	AB		06M
DP 21	96	AB		07M



DP 21/96 G4/01M



DG 19 G4/01M



DP 21/96 G4/02M



DG 19 G4/02M



DP 21/96 G4/03M



DG 19 G4/03M





DP 21/96 G4/05M



DG 19 G4/05M

**DG 19**

		
DP 19		01M
DP 19		02M
DP 19		03M
DP 19		05M
DP 19		06M
DP 19		07M



DP 21/96 G4/06M



DG 19 G4/06M

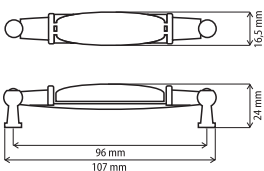
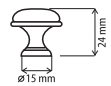

DP 21/96 G4/07M



DG 19 G4/07M



## D-304

	↔	△	⊖
D-304	96	G1	03B
D-304	96	G4	03R
D-304	96	G6	01W
D-304	96	G28	03B



D-304/96 G28/03B



D-304/96 G4/03R



D-304/96 G1/03B

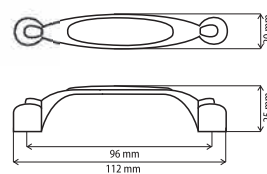

K-301 G28/03B



K-301 G4/03R



K-301 G1/03B

## K-301

	△	⊖
K-301	G1	03B
K-301	G4	03B
K-301	G6	01W
K-301	G28	03B



D-304/96 G6/01W



K-301 G6/01W

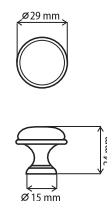



### D-300

	↔	△	⊕
D-300	160	G4	10
D-300	160	G4	11
D-300	128	G4	10
D-300	128	G4	11



D-300/160 G4/10

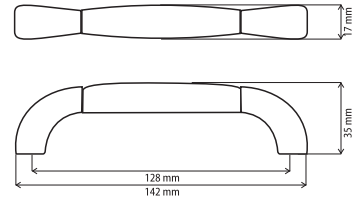

D-300/160 G4/11



D-300/128 G4/10



K-300/L 10

### K-300

	⊕
K-300 L	10
K-300 L	11
K-300 L	12



D-300/128 G4/11



K-300/L 11

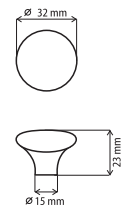

D-300/128 G28/12







D-300/128 G4/12

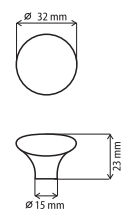

K-300/L 12



## D-300

				
D-300	160	G2	01W	
D-300	160	G4	07M	
D-300	128	G2	01W	
D-300	128	G4	07M	
D-300	128	G4	12	
D-300	128	G28	12	



D-300/160 G4/07M

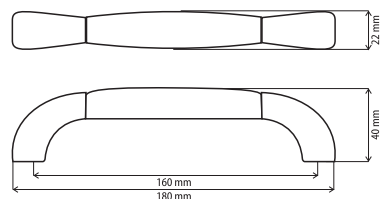

D-300/128 G4/07M



K-302 G2/01W

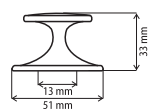
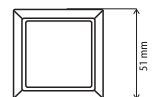

K-302 G4/07M

## K-302

			
K-302	G2	01W	
K-302	G4	07M	



D-300/160 G2/01W



D-300/128 G2/01W



**D-126  
K-126**

D-126	128	G4	12
K-126	L	G4	12



**D-126/128 G4**



**K-126 G4**

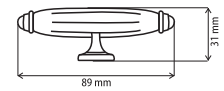
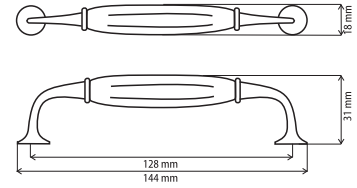

**D-305**

D-305	96	GK	12



**D-305 G4/12**

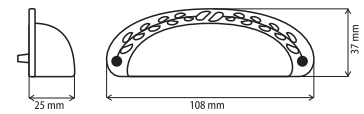
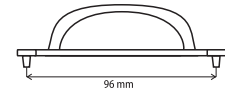

**D-307  
D-306**

D-307	128	G4	14
D-307	96	G4	14
D-306	128	G4	13
D-306	96	G4	13



**D-307/128 G4/14**



**D-307/96 G4/14**



**D-306/128 G4/13**



**D-306/96 G4/13**

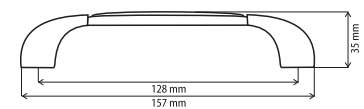

### DP 181

DP 181 | 96 | AB | 01M



DP 181/96 G4/01M

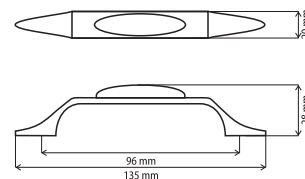

### D-302 G4/9M+SD 302 G4

D-302+SD 302 | 96 | G4 | 09M



D-302 G4/9M+SD-302 G4

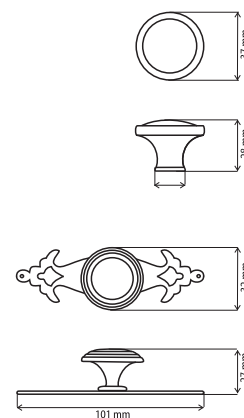

### D-301

D-301 | 107 | G4 | 07M



D-301/107 G4/07M

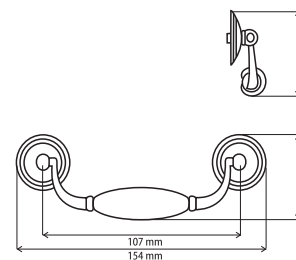

### D-303

D-303 | 160 | G6 | 05M



D-303/160 G6/05M

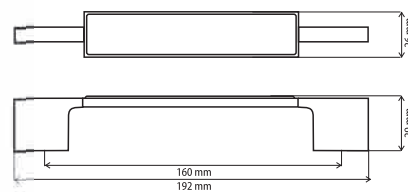





# Ретро

82-95



## Ретро-Retro

Современная мебель, отображающая ретро-стиль разных годов XX века, разнообразна. Каждое десятилетие внесло моду на свою цветовую гамму и оттенки. Сегодня в фаворе старинный гарнитур из дерева или разнообразных материалов имитирующих дерево. Ансамблем к ретро мебели превосходно идет ручка цвета латуни или бронзы.

**D-104  
K-104**

↪	↔	△
D-104	96	AB
D-104	96	G4
D-104	64	AB
D-104	64	G4

⌣	△
K-104	AB
K-104	G4



D-104 96/G4



D-104 64/AB



K-104 AB

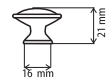
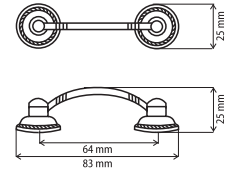
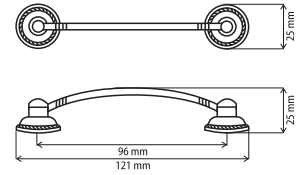

**D-103**

↪	↔	△
D-103	96	G4
D-103	64	G4

⌣	△
K-103	G4



D-103 96/G4



K-103 G4

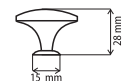
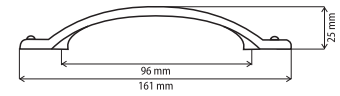

**D-100  
K-100**

↪	↔	△
D-100	96	AB
D-100	96	G4

⌣	△
K-100	AB
K-100	G4



D-100 96/G4



K-100 AB

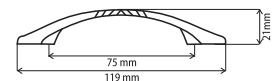
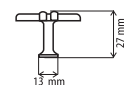



**D-102  
K-102**

↪	↔	△
D-102	128	G4
D-102	96	G4
D-102	64	G4
⌣	△	
K-102	G4	



**D-102 128/G4**



**D-102 96/G4**



**K-102 G4**



**D-102 64/G4**

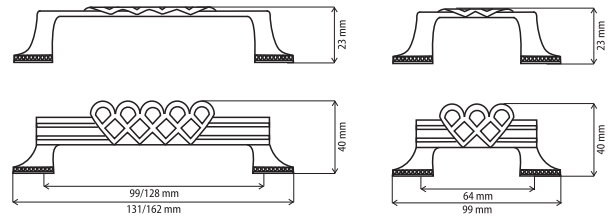
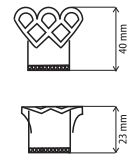

**DUG 19  
DGR 08  
KGR 61**

↪	↔	△
DUG 19	96	G4
⌣	△	
DGR 08	G4	
⌣	△	
KR 61	G4	

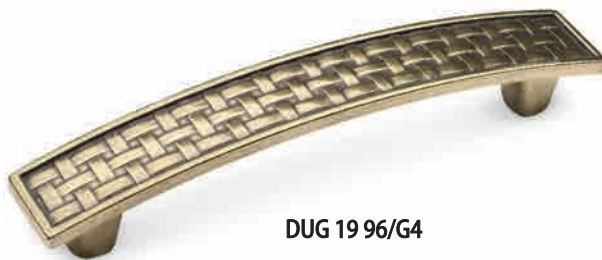

**DUG 19 96/G4**







**KR 61 G4**

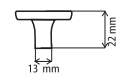
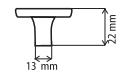
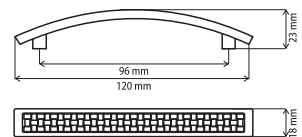

**DGR 08 G4**



**D-140  
K-140**

		
D-140	128	G4
D-140	96	G4
		
K-140	G4	







**D-140 96/G4**

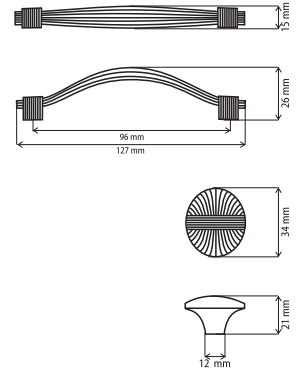

**K-140 G4**



**D-115  
K-115**

		
D-115	128	G4
		
K-115	G4	



**D-115 128/G4**



**K-115 G4**

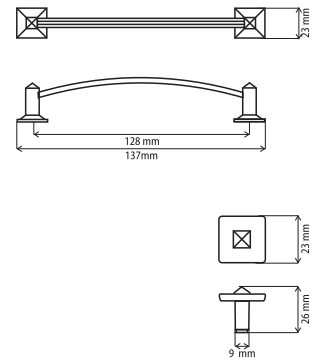

**DUG 32  
DGG 32**

		
DUG 32	128	G4
DUG 32	96	G4
		
DGG 32	G4	







**DUG 32 96/G4**

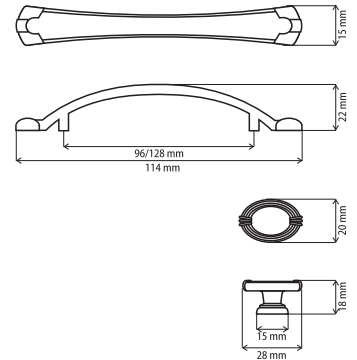

**DGG 32 G4**



**D-122  
K-105**

		
D-122	128	G4
D-122	96	G4
		
K-105	G4	



**D-122 96/G4**



**K-105 G4**

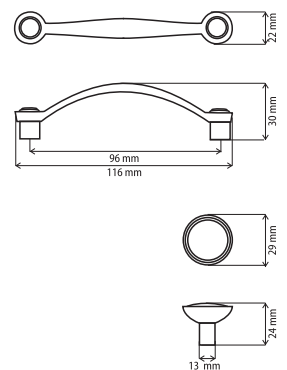





DC-01  
DC-02  
DG-11  
DG-12

↔	↔	△
DC-01	96	AB
DC-02	196	AB
DC-02	128	AB
DC-02	96	AB

⌣	△
DG-11	AB
DG-12	AV



DC-02 128/AB



DC-01 96/AB



DG-11 G4



DG-12 G4

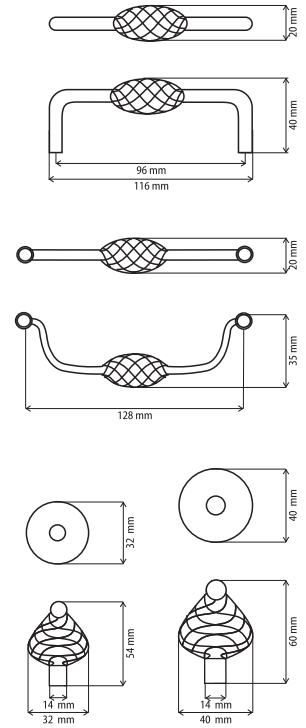

D-116  
K-116

↔	↔	△
D-116	128	G4

⌣	△
K-116	G4



D-116 128/G4



K-116 G4

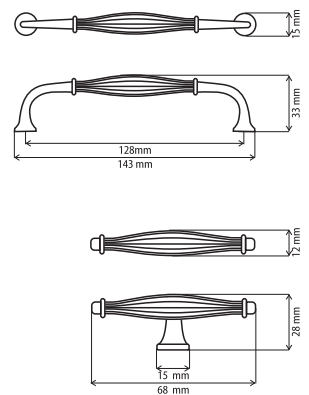



**D-310**  
**D-311**

	↔	△	⊖
D-310	128	AEB	W
D-310	64	AEB	W
D-311	128	AEB	B
D-311	64	AEB	B



**D-310 64/AEB W**



**D-311 64/AEB B**



**D-311 128/AEB B**



**D-310 128/AEB W**

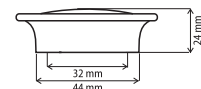
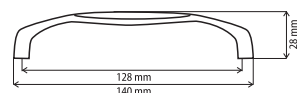
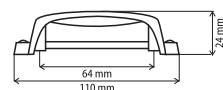

**K-310**  
**K-311**

	↔	△	⊖
K-310	32	AEB	W
K-311	32	AEB	B



**K-310 32/AEB W**



**K-311 32/AEB B**



### D-137

D-137 | 96 | G4



D-137 96/G4

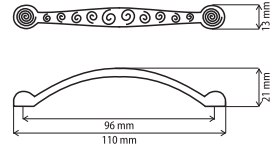

### D-108 K-108

D-108 | 96 | G4  
  
 K-108 | G4



D-108 96/G4



K-108 G4

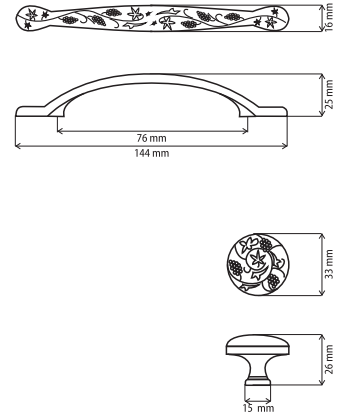

### D-109

D-109 | 96 | G4  
 D-109 | 96 | G21



D-109 96/G4

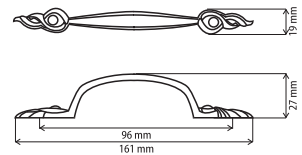

### D-127

D-127 | 96 | G23



D-127 96/G23

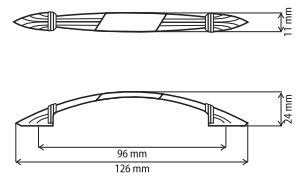

### D-138



D-138 | 96 | G4

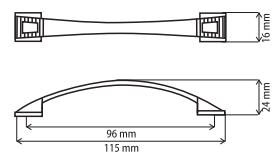

D-138 96/G4



## DUR 10



		
DUR 10	128	G4
DUR 10	96	G4

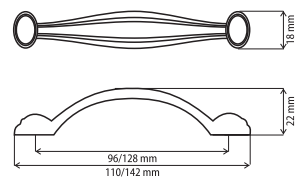

DUR 10 128/G4



## SS 10



		
SS 10	96	G28
SS 10	96	G4

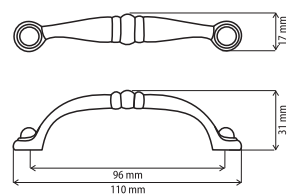

SS 10 96/G4



## DP 82



		
DP 82	96	G4

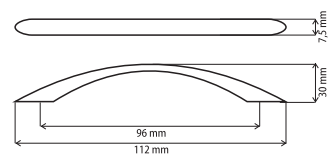

DP 82/96 G4



## DUR 07

		
DUR 07	96	G4



DUR 07 96/G4

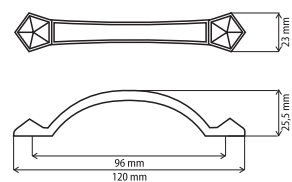

## DN 88

		
DN 88	128	G4
DN 88	96	G4



DN 88/96 G4

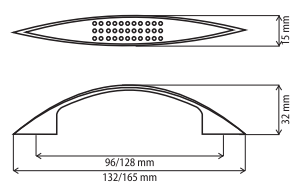



### D-113 K-113

D-113	128	G4
D-113	96	G4
K-113	G4	



D-113 96/G4



K-113 G4

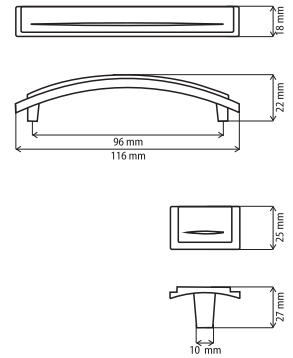

### D-106

D-106	128	G4
D-106	96	G4



D-106 128/G4

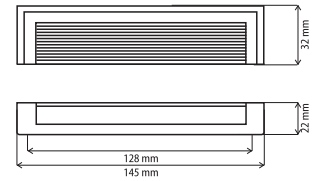

### D-105

D-105	128	G4
D-105	96	G4

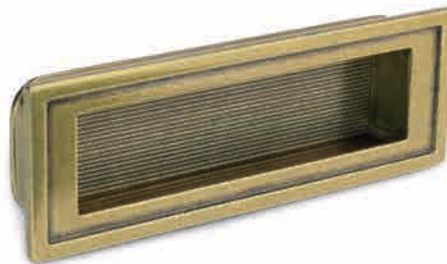

D-105 96/G4

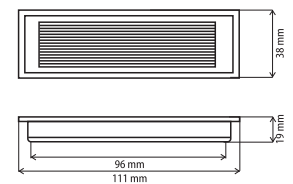

### D-110

D-110	160	G4
D-110	128	G4
D-110	96	G4



D-110 96/G4

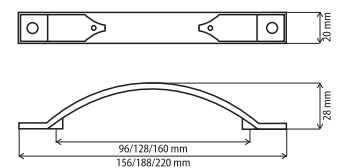

**GG 12  
DG 31**

☐	△
GG 12	G4
DG 31	G4



**GG 12 G4**



**DG 31 G4**

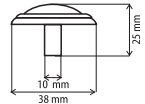
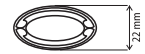
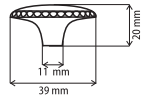
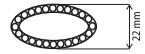

**K-106  
K-135**

☐	△
K-106	AB
K-135	G4



**K-106 AB**



**K-135 G4**

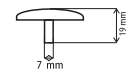
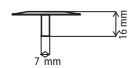

**K-107**

☐	△
K-107	AB
K-107	G23
K-107	G28
K-107	G4
K-107	G5



**K-107 G28**

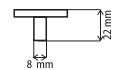



## K-110

   
 K-110 | G4



K-110 G4

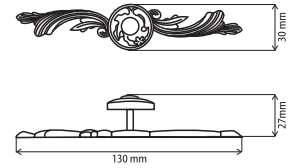

## K-138 + SD 138 DGG 233 + DSD 233

   
 K-138 + SD 138 | G4  
 DGG 233 + DSD 233 L | G4  
 DGG 233 + DSD 233 S | G4



K-138 + SD 138 G4



DGG 233 + DSD 233 L/G4

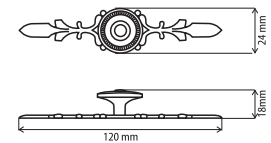
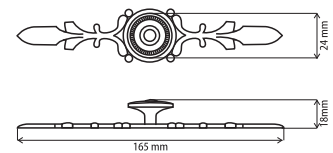
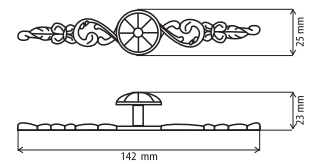

## K-112

   
 K-112 | G4



K-112 G4

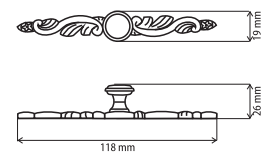

## K-101 + SD 101

   
 K-101 + SD 101 | G4



K-101 G4 + SD-101 G4

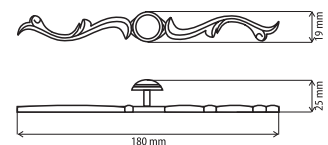

### DGG 36 + DSD 36



  
 DGG 36 + DSD 36 | G4

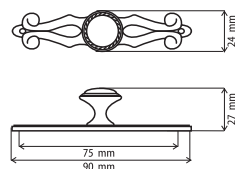

DGG 36 + DSD 36 G4



### DGG 09 + DSD 09 DGG 42 + DSD 07



  
 DGG 09 + DSD 09 | G4  
 DGG 42 + DSD 07 | G4



DGG 09 + DSD 09 G4

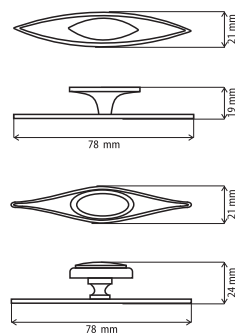

DGG 42 + DSD 07 G4



### E-570

  
 E-570 | G3  
 E-570 | G4



E-570 G4

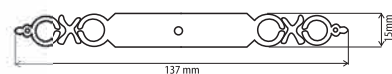

**K-129  
K-128**

   
 K-129 | G4  
 K-128 | G4



**K-128 G4**



**K-129 G4**

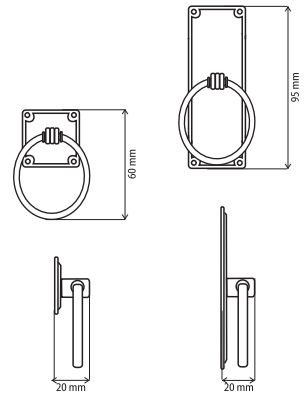

**K-132  
K-130**

   
 K-132 | G4  
 K-130 | G4





**K-132 G4**

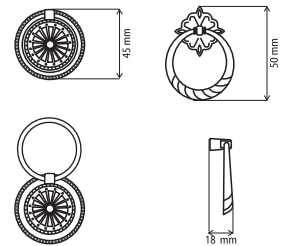

**K-130 G4**



**D-125**

    
 D-125 | 96 | G4



**D-125 96/G4**

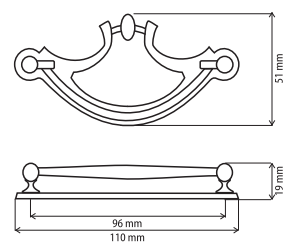

**B-700  
KR 31**

☐	△
B-700	G1A
B-700	G4A
KR 31	G4



**B-700 G1A**



**KR 31 G4**

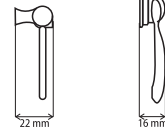
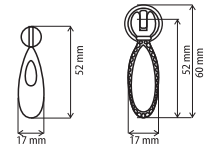

**DT 07  
DKT 01  
DKT 05**

☐	△
DT 07	G3
DT 07	G4
DKT 01	G1
DKT 01	G2
DKT 01	G3
DKT 01	G4
DKT 05	G3
DKT 05	G4



**DT 07 G3**



**DKT 01 G3**



**DKT 05 G3**

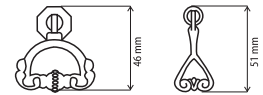
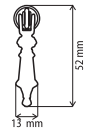

**E-340  
DSD 28**

☐	△
E-340	G3
E-340	G4
DSD 28	G3
DSD 28	G4



**E-340 G4**



**DSD 28 G4**

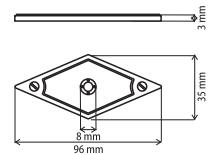
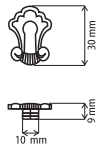

**E-281  
E-241**

☐	△
E-281	G3
E-281	G4
E-241	G3
E-241	G4



**E-281 G3**



**E-241 G4**

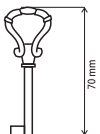
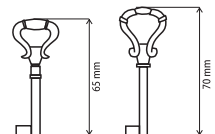



# Крючки

Крючки - Hooks

Крючок - одно из самых ранних изобретений человечества. Прародитель мебельных крючков - рыболовный. Возраст самого древнего из них - 9 000 лет. Форма каменных и деревянных крючков периода палеолита практически идентична современным крючкам из металла. А вот дизайн крючков в наше время может удовлетворить любой запрос - классик и модерн, ретро, а также детские. Весьма функциональные - одинарные, двойные и даже тройные.

96-99



DW 07  
DW 08

Крючок	Группа
DW 07	G2
DW 07	G3
DW 07	G5
DW 07	G6
DW 08	G2
DW 08	G3
DW 08	G5
DW 08	G6



DW 07 G5



DW 08 G3

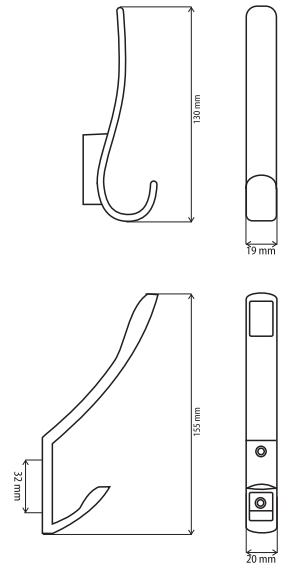

DW 355  
DW 341

Крючок	Группа
DW 355	G2
DW 355	G3
DW 355	G5
DW 355	G6
DW 341	G2
DW 341	G3
DW 341	G5
DW 341	G6



DW 355 G2



DW 341 G5

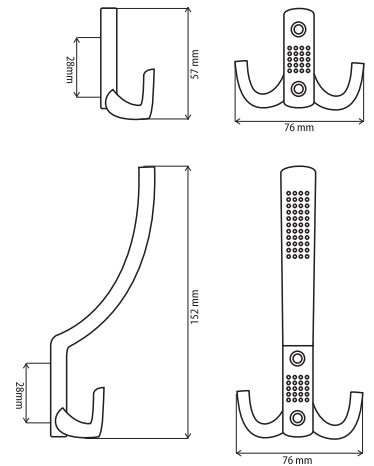

DW 59  
DW 89

Крючок	Группа
DW 59	AB
DW 59	G2
DW 59	G3
DW 59	G4
DW 59	G5
DW 59	G6
DW 89	AB
DW 89	G2
DW 89	G3
DW 89	G5
DW 89	G6



DW 59 G5



DW 89 G5

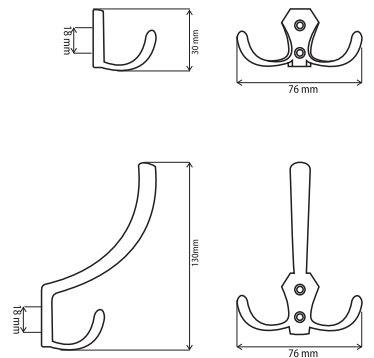

**DW 49  
DW 10**

DW 49	G2
DW 49	G3
DW 49	G5
DW 49	G6
DW 10	G2
DW 10	G5



**DW 49 G5**



**DW 10 G2**

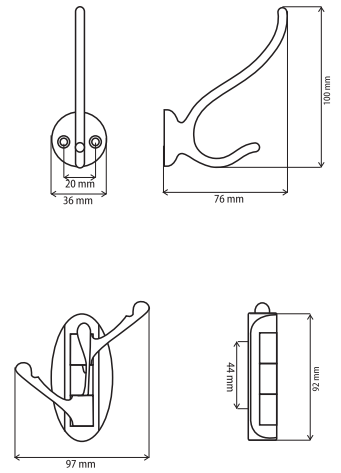

**DW 11  
DW 12  
DW 29**

DW 11	G2
DW 11	G3
DW 11	G5
DW 11	G6
DW 12	G2
DW 12	G3
DW 12	G5
DW 29	G2
DW 29	G3
DW 29	G5



**DW 11 G5**



**DW 12 G5**



**DW 29 G3**

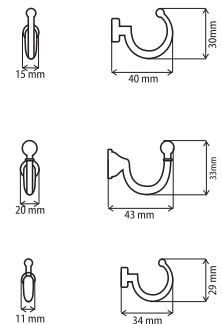

**DW 19  
DW 39**

DW 19	AB
DW 19	G2
DW 19	G3
DW 19	G5
DW 19	G6
DW 39	G2
DW 39	G3
DW 39	G5
DW 39	G6



**DW 19**



**DW 39 G5**

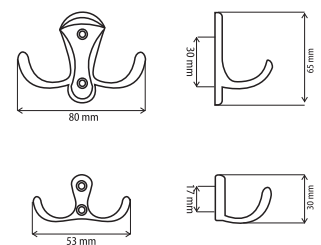

W-102  
W-112  
W-122

	△
W-102	G4
W-112	G4
W-122	G4



W-112 G4



W-122 G4



W-102 G4

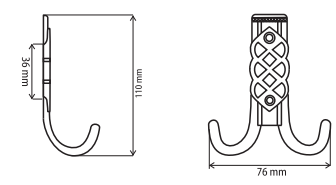
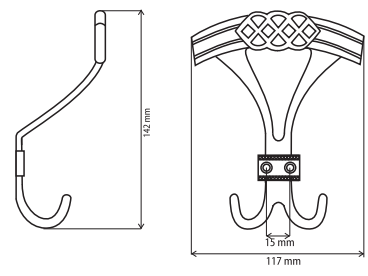
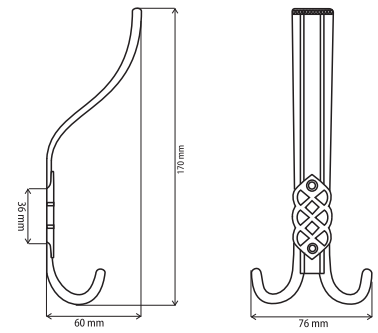

W-105  
W-125

	△
W-105	G4
W-125	G4



W-105 G4



W-125 G4

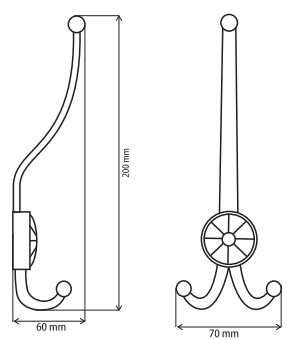
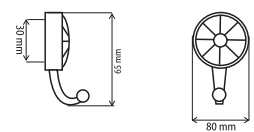



# Покрyтия и вставки

## Покрyтия

G1		Темный никель
G1/C		Темный никель с античной медью
G2		Хром
G3		Золото
G4		Античная бронза
AB		Античная бронза (полированная, глянцевая)
G5		Никель (матовый)
G6		Хром (матовый)
G7		Хром (матовый с эффектом нержавеющей стали)
G8		Никель (матовый с эффектом нержавеющей стали)
G9		Серебро (матовое)
G15		Античная темная медь (матовая)
G16		Античный никель (матовый)
G17		Античная бронза (полированная, матовая)
G21		Античная латунь
G23 (RB)		Античная медь (глянцевая)
G28		Темное античное серебро
G30		Белое серебро
P9		Черная эмаль (глянцевая)

## Керамические вставки

W	
M	
R	
B	
01	
02	
03	
05	
06	
07	
09	
10	
11	
12	
13	
14	

## Вставки однотонные

K3		Серый
K4		Вишня
K6		Бук
K8		Коричневый
K10		Белый
K11		Черный
K28		Кальвадос
K32		Бирюзовый
K33		Голубой
K34		Светло фиолетовый
K35		Фиолетовый
K37		Прозрачный белый
GLASS		Стекло
BRN GLASS		Коричневое стекло

## Вставки древоподобные

D4		Бук
D6		Вишня
D7		Дуб светлый
D8		Дуб темный
D9		Махонь
D12		Венге
D19		Орех
D28		Кальвадос
D29		Орех италия
D30		Ольха

## Расшифровка символов

D-304/96 G4/03R







# Код товара

код ручки	номер страницы	код ручки	номер страницы	код ручки	номер страницы
B-700	95	D-716	49	DGG 42	93
D-001	63	D-717	47	DGG 233	92
D-002	64	D-720	43	DGR 08	84
D-003	61	D-725	36	DK 20	45
D-069	50	D-726	36	DK 30	45
D-070	63	D-730	38	DKT 01	95
D-071	60	D-731	39	DKT 05	95
D-072	59	D-732	40	DL 10	11
D-100	83	D-734	39	DL 10A	10
D-102	84	D-740	42	DL 11	13
D-103	83	D-741	48	DL 17	23
D-104	83	D-746	37	DL 30	13
D-105	90	D-747	49	DL 33	12
D-106	90	D-748	44	DN 01	69
D-108	88	D-749	35	DN 06	61
D-109	88	D-750	48	DN 11	57
D-110	90	D-751	45	DN 12	57
D-111	35	D-752	44	DN 13	60
D-113	90	D-753	35	DN 14	60
D-115	85	D-755	43	DN 17	60
D-116	86	D-756	43	DN 18	60
D-122	85	D-761	41	DN 43	57
D-125	94	D-800	64	DN 44	56
D-126	80	DC-01	86	DN 45	65
D-127	88	DC-02	86	DN 49	55
D-137	88	DD 01	69	DN 50	47
D-138	88	DD 02	69	DN 54	37
D-140	85	DD 10	67	DN 78	40
D-200	66	DD 12	51	DN 81	23, 61
D-210	66	DD 61	69	DN 82	24
D-215	66	DE 60	25	DN 83	56
D-300	78, 79	DF 01	22	DN 87	53
D-301	81	DF 19	66	DN 88	53, 89
D-302	81	DF 88	66	DN 89	63
D-303	81	DG 01	68	DN 90	61
D-304	77	DG 02	55	DN 92	58
D-305	80	DG 059	54	DN 94	65
D-306	80	DG 07	68	DN 96	59
D-307	80	DG 09	68	DN 97	64
D-310	87	DG-11	86	DN 98	59
D-311	87	DG-12	86	DP 19	75
D-433	54	DG 16	68	DP 21	76
D-434	54	DG 19	76	DP 38	57
D-450	44	DG 20	75	DP 81	56
D-473	66	DG 29	68	DP 82	56, 89
D-663	55	DG 31	91	DP 83	56
D-664	55	DG 32	68	DP 181	81
D-701	47	DG 33	68	DR 08	54
D-702	49	DG 66	53	DR 10	41
D-703	38	DG 246	68	DR 15	20
D-704	40	DG 250	xx	DR 49	14
D-705	38	DG 256	66	DR 52	16
D-706	39	DG 295	55	DR 53	17
D-707	39	DGA 09	68	DR 55	18
D-708	39	DGA 20	68	DR 56	21
D-709	38	DGA 27	51	DR 57	20
D-710	40	DGA 28	53	DR 58	24
D-712	43	DGG 09	93	DR 60	21
D-714	37	DGG 32	85	DRR 08	54
D-715	37	DGG 36	93	DRU 08	42

код ручки	номер страницы	код ручки	номер страницы	код ручки	номер страницы
DRU 09	42	K-108	88	W-102	99
DRU 20	42	K-110	92	W-105	99
DS 05	57	K-111	35	W-112	99
DS 07	15	K-112	92	W-122	99
DS 09	58	K-113	90	W-125	99
DS 24	57	K-115	85	WN 01	30
DS 26	58	K-116	86	WN 02	30
DS 27	58	K-126	80	WR 04	32
DS 29	63	K-128	94	WR 05	32
DSD 07	93	K-129	94	WR 06	31
DSD 09	93	K-130	94	WR 07	31
DSD 28	95	K-132	94	БАБОЧКА	71
DSD 36	93	K-135	91	ЗАЙЧИК	71
DSD 233	92	K-138	92	КЛУБНИКА	73
DT 07	22, 95	K-140	85	МЕДВЕЖОНОК	71
DT 40	65	K-300	78	МОРСКАЯ ЗВЕЗДА	72
DU 01	49	K-301	77	ПАНДА	71
DU 02	41	K-302	79	ПОДСОЛНУХ	73
DU 03	41	K-310	87	РОЗА	73
DU 04	65	K-311	87	РЫБКА ГОЛУБАЯ	72
DU 08	47	K-700	51	РЫБКА ЖЕЛТАЯ	72
DU 21	08	K-701	51	РЫБКА КРАСНАЯ	72
DU 22	09	K-702	50	СЛОН	71
DUG 14	37	K-704	50	ЧЕРЕПАХА	72
DUG 19	84	K-705	51	ЦИКАДА	71
DUG 20	55	K-725	36		
DUG 32	85	K-728	51		
DUR 07	89	K-729	51		
DUR 10	89	K-749	35		
DUU 21	65	KD 10L	67		
DUU 36	65	KD 10S	67		
DUU 39	63	KF 01	22		
DUU 71	64	KGR 61	84		
DV 20	26	KL 07	15		
DV 21	26	KL 17	23		
DW 07	97	KR 15	20		
DW 08	97	KR 31	95		
DW 10	98	KR 52	16		
DW 11	98	KR 53	17		
DW 12	98	KR 55	18		
DW 19	98	KR 56	21		
DW 29	98	KR 60	21		
DW 39	98	KU 01	07		
DW 49	98	KU 02	05		
DW 59	97	KU 03	06		
DW 89	97	KU 04	19		
DW 341	97	KU 05	27		
DW 355	97	KU 06	28		
E-241	95	KU 31	29		
E-281	95	KV 21	26		
E-340	95	M-005	30		
E-570	93	M-006	30		
GG 12	91	PL 11	31		
K-100	83	SD 101	92		
K-101	92	SD 138	92		
K-102	84	SD 302	81		
K-104	83	SS 10	89		
K-105	85	SS 6526	58		
K-106	91	SS 6528	58		
K-107	91	UA 06	41		